

**Climate regulation,  
irrigation and  
mechanisation  
devices**

# Catalogue



**20  
24**



**Anjou  
Automation**

INNOVATION IS PART OF OUR CULTURE

# General terms and conditions of sale

(applicable from 1st December 2023)

## 1 - GENERAL TERMS AND CONDITIONS

Except in the case of a special, written agreement, all orders automatically imply the customer's acceptance of these conditions, notwithstanding any contrary clause which may appear in the customer's general terms and conditions of purchase.

## 2 - ORDERS - ESTIMATES

Orders only become final after written or tacit acceptance by ANJOU AUTOMATION, hereinafter referred to as "the Company". If an estimate is provided, the order only becomes final after returning the accepted estimate to the Company by post, fax or by any other means of transmission, within eight days of its issue. Any modification of an order or estimate shall be subject to a written agreement between the Company and the customer.

## 3 - DELIVERY TIMES

Deliveries are made according to supply and transport availabilities, in the order of arrival of orders and according to the indications provided by the Company in its acceptance. The Company is authorised to make total or partial deliveries. Delivery times are provided for information purposes and are not binding on the Company, especially in cases of force majeure or unforeseeable circumstances. No delay in delivery may give rise to the application of penalties or damages, to any withholding or the cancellation of the order. In any event, deliveries may only be made to a customer if it is up to date with its obligations vis-à-vis the Company.

## 4 - DELIVERIES

Prices are given excluding tax, ex-works, packaging included. Unless otherwise indicated in the order or on the accepted estimate, all orders are shipped excluding carriage. All costs of an express delivery shall be fully borne by the customer who makes such a request. Goods become the customer's property on leaving the Company's workshops, subject to the retention of title clause below. Consequently, all transport, customs, insurance and handling operations are carried out at the customer's expense and risk. The customer must check the compliance of the shipment, and for any damage or missing items and, if necessary, make the necessary reservations, by registered letter with acknowledgement of receipt and in the legal time limits, to the concerned bodies and carriers. The customer shall notify this to the Company. The return of a product must be subject to a formal agreement between the Company and the customer.

## 5 - WARRANTIES

The Company has a duty to deliver goods which comply with the contract and is liable for any lack of conformity which may exist on delivery. To comply with the contract, the product must:

- Be fit for any use usually expected of such goods and, when applicable, match the description given by the Company, and have the characteristics it presented to the customer in the form of samples or models;
- Have the qualities the customer can legitimately expect given the declarations made by the Company, in particular in its advertising;
- Or present the characteristics defined in mutual agreement between the parties;
- Or be fit for any special use required by the customer, which the Company has been informed of and accepted.

Electrical devices are guaranteed for one year from the date of purchase, against any manufacturing defect. The warranty entirely covers parts and labour. The warranty covers the replacement of any defective part, but does not cover breakages caused by dropping or knocks, deterioration caused by abnormal use, connection errors or non-compliance with the conditions of use indicated in the user guide.

## 6 - SALES TERMS AND CONDITIONS SPECIFIC TO THE "GREENHOUSE CLIMATE REGULATION" ACTIVITY

ANJOU AUTOMATION's climate controllers are not safety devices. Therefore, it is the responsibility of each buyer and/or operator to implement all control and alarm systems necessary for the security of its greenhouses (both for the structures and for the crops). The Company remains at the disposal of its customers or operators for all advice on this matter.

## 7 - PRICES

The prices and information appearing in the Company's catalogues or other advertising material are the sole responsibility of the Company, which reserves the right to make any modifications in the form, dimensions, materials or weight of its products presented or described, without any obligation to modify products previously delivered or already ordered. Goods are invoiced on the basis of the price in force at the time of the order. Payments are made to the Company's registered office. Unless otherwise stipulated, orders are payable in cash when the goods are collected, net and without discount. Any other payment terms must be subject to a prior agreement. In the absence of payment of a single term, all amounts due shall be immediately payable, without formalities, and shall be accompanied by a penalty equal to 3 times the legal interest rate. In addition, a flat-rate indemnity for recovery costs of an amount of 40 Euros will be automatically due, without formalities. If the recovery costs are higher than this flat-rate amount, an additional indemnity will be due, on the presentation of supporting documents. The Company may also suspend any further deliveries.

## 8 - RETENTION OF TITLE

The Company retains full ownership of the goods sold until payment in full by the customer. However, the risks of loss, theft or deterioration of the goods are borne exclusively by the customer as soon as they are made available to it. The non-payment of any amount when due may give rise to the claim of the existing goods.

## 9 - INTELLECTUAL PROPERTY

The designs, models, plans and estimates and, generally, the documents of any nature communicated by the Company are the exclusive intellectual property of the Company: they may not be communicated or executed without its written authorisation. They must be returned upon the Company's simple request.

## 10 - APPLICATION OF CONVENTIONS

No delay, omission or tolerance by the Company in the exercise of one of its rights hereunder shall constitute a waiver by the Company to assert this right.

## 11 - ATTRIBUTION OF JURISDICTION

In the event of a dispute, the Company and the customer concerned shall settle it by means of arbitration carried out by a single arbitrator acting as amiable compositeur, chosen by common agreement or, otherwise, appointed at the request of the most diligent party by the President of the Commercial Court of Roche-sur-Yon. The parties waive any appeal and any recourse against the arbitral award which will be rendered final and undertake to comply therewith, without any enforcement procedure.

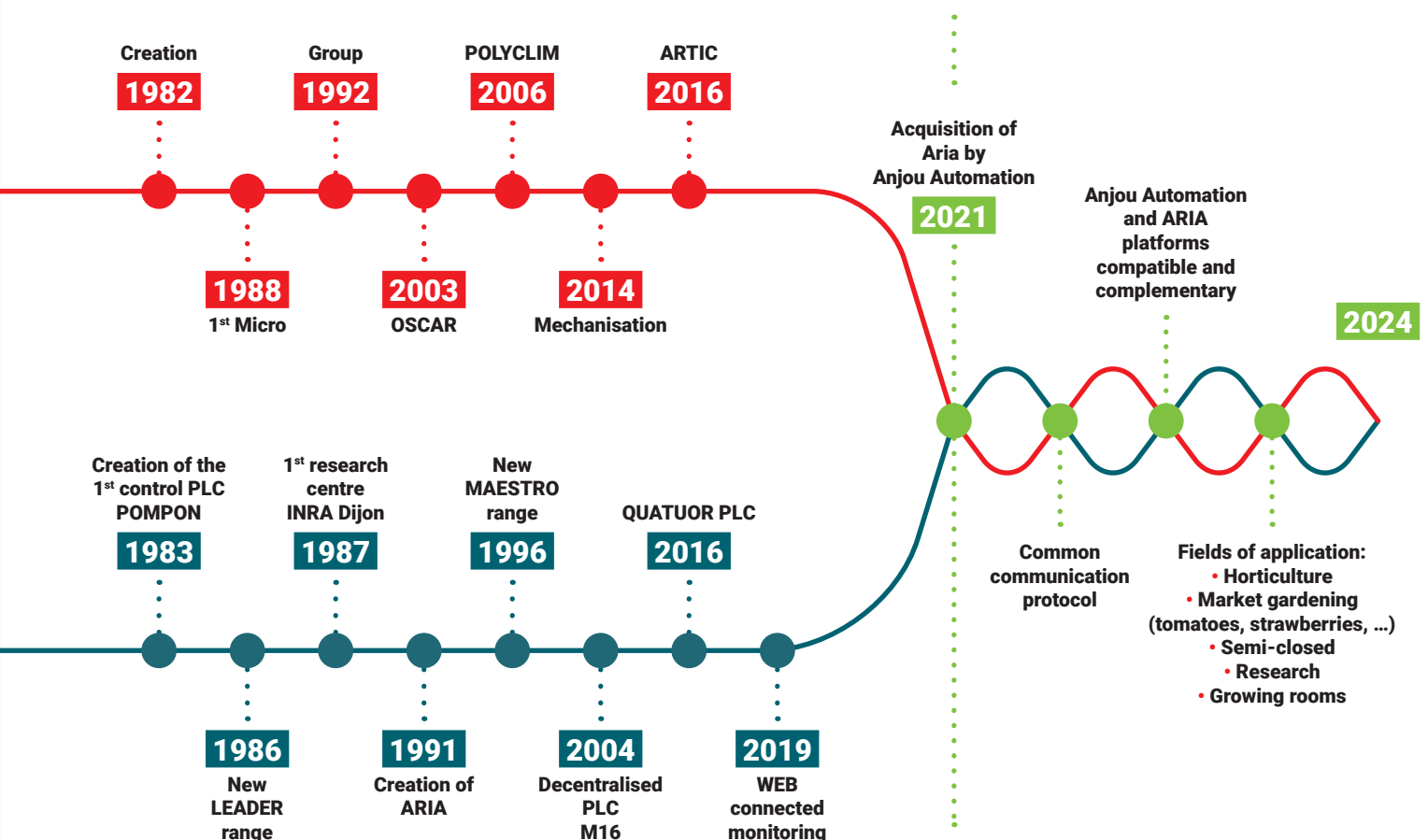

**ARIA puts technology at the service of growing condition control. Its climate regulation systems for glass and plastic greenhouses and irrigation and fertilisation management can be customised to meet the most varied requirements.**

From interfaced sensors, to PLCs and monitoring, ARIA masters the entire design, development and production chain, both for the electronics and the software, and thereby guarantees sustained bespoke and high end services.

Domaine de Villemorant  
 Ecoparc de Sologne  
 41210 Neung sur Beuvron • FRANCE  
 Tél. 02 54 95 67 67  
 info@ariafrance.fr  
[www.ariafrance.fr](http://www.ariafrance.fr)





**Anjou Automation** was created in 1982. It designs and manufactures regulation and automation equipment for sectors such as the agri-food, environment and automotive industries.

Based on techniques that use digital electronics and industrial IT, the business was able to develop innovating lines of standard products that are perfectly suited to user needs and is also available to create bespoke products.

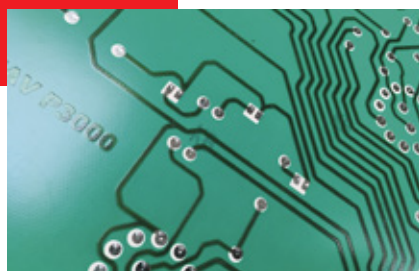

**Today, Anjou Automation** is recognised all over the world for its greenhouse climate and irrigation regulators, its weather sensors and its Mechanisation line.

# New in 2024

## REMOTE ACCESS ON PREVIOUS GENERATION CONTROLLERS

p. 23

Take control of your previous-generation controllers remotely by phone, tablet or PC.



### COMPATIBLE WITH:

- OSCAR
- MASTERCLIM
- MICRORAMPE
- POLYCLIM (except 200 product line)
- IRRI 12
- MAXICLIM NG

### HARDWARE CONFIGURATION:

- ARTIC Sentinel (p.27)
- 4G BOX (p.23) + ANJOU DATA subscription

## NEW RANGE OF ANJOU LIGHT DRIVE (ALD) GEAR MOTORS

p. 34

Lighter, more compact, easier to wire and with the same patented limit switch system.

### APPLICATIONS:

- Roll-up side ventilation
- Direct rolling on a cart
- Ridge ventilation / Shading screen
- Shade spacer



## ANJOU DATA: YOUR MACHINE TO MACHINE (M2M) SIM CARD

p. 22



[www.anjou-data.fr](http://www.anjou-data.fr)

No more headaches when choosing your M2M subscription. Anjou Data offers a SIM Card + Secure Link subscription that meets your needs for connecting to your Anjou Automation controllers.

- One-year subscription
- Tacit renewal on the anniversary date
- Offer tailored to your needs
- No need to visit a store or spend hours searching for the right subscription
- A secure link and your data protected

# Anjou Automation activities

## HORTICULTURE - MARKET GARDENING

### CLIMATE MANAGEMENT



### MECHANISATION



### IRRIGATION MANAGEMENT



### FERTILISATION MANAGEMENT



### POWER / ELECTRICITY



### PUMPING MANAGEMENT



## AGRI-FOOD INDUSTRY

### LEVEL DETECTION



## AUTOMOTIVE

### CONTROL PANEL



## MACHINERY

### REMOTE MACHINE CONTROL



# Contents

General terms and conditions of sale	2
Anjou - Aria	3
Company presentation	4
Anjou Data concept	5
Anjou Automation activities	6-7

## CLIMATE 8-21

Selection guide	8
Available software functions	9
Choosing the right regulator	10-11
RGAP / CLIMTOP / VIGICALL	12
POLYCLIM 2000 product line	13
POLYCLIM NG	14-15
KAIROS	16-17
ARTIC	18-21

## CONNECTIVITY 22-27

Anjou Data	22
4G Box - SIMA	23
Regulator display	24-25
Supervision	26-27

## SENSORS 28-29

Indoor sensors	28
Outdoor sensors	29

## POWER 30-33

Motor casings	30
Power boxes	31
Power cabinets	32
MISSI range	33

## MECHANISATION 34-45

Side ventilation gear motor	34-35
Ridge ventilation / shading gear motor	36-37
Cart-mounted gear motor	38-39
Shade spreading gear motor	40-41
Manual gearboxes	42-43
Manual gearbox accessories	44
Telescopic arms	45

## IRRIGATION 46-51

Irrigation trolley management	46
Selection guide	47
POLYPROG 12 - MICROFERTI	48
Anjou Fertil	49
NERO	50-51

## PUMPING 52-55

VIZIA	53-53
Direct / soft start	54
Accessories	54
Soft start cabinet	55



# SELECTION GUIDE

## POLYCLIM 2000 PRODUCT LINE

- Management of one climate
- Pre-defined functions depending on the model
- Delivered with sensor
- Built-in manual controls
- Non-supervisable



More information on page 13

## POLYCLIM NG

- Management of one climate zone - several zones on specific configurations
- Pre-defined functions with possibility of adding functions
- Built-in manual controls
- Embedded website and compatible with Supervision



More information on page 14

## KAIROS

- Management of 1 to 6 climate zones depending on the number of outputs per zone
- Functions configurable depending on the project
- Embedded website and compatible with Supervision



More information on page 16

## ARTIC

- Management of 1 to 12 climate zones
- Irrigation, fertilisation and boiler room management
- Functions configurable depending on the project
- Embedded or box version
- Embedded web site and compatible with Supervision



More information on page 18



# AVAILABLE SOFTWARE FUNCTIONS







FUNCTIONS AVAILABLE

Functions	Description	Number of outputs
<b>Ventilation on 1 side</b>	Regulation proportional to the ambient temperature Weather safety systems (wind and rain) Outside influences (wind, wind vane, outside temperature and sunlight)	2
<b>Ventilation on both sides</b>	Temperature integration over 24 hours	4
<b>Shade screen / thermal screen</b>	Shading mode depending on sunlight (Watt/m <sup>2</sup> ) Thermal mode depending on the ambient temperature Outside influences (outside temperature)	2
<b>Heating ON/OFF</b>	Thermostatic control according to the ambient temperature Possibility of managing a circulator at one water temperature separately from the unit heater	1
<b>Heating : 3-way valve + circulator</b>	Proportional control according to the ambient temperature and the water circuit temperature Outside influences (wind, outside temperature and sunlight) Circulator control according to the water circuit temperature Temperature integration over 24 hours	3
<b>Deshumidification</b>	Regulation of the ambient hygrometry Influence on ventilation, heating and shading	-
<b>Inflation</b>	Turbine operation control by "pulse and variation" Outside influence (wind speed)	1
<b>Fog</b>	Regulation proportional to the ambient temperature and/or hygrometry Influence on ventilation	1
<b>Air mixer</b>	Thermostatic control depending on the ambient temperature and/or hygrometry Possible combination with heating operation	1
<b>Cooling</b>	Control of a pump and 1 to 3 extractor pumps depending on the ambient temperature Influence on ventilation	2 to 4
<b>CO2</b>	CO2 injection control by "pulse and variation" Influence on ventilation	1
<b>Clock</b>	Starting by timer or according to the sensors connected (adjustable thresholds) Applications: photosynthetic lighting, irrigation, etc...	1
<b>Alarm</b>	Activation on passing a top or bottom threshold (temperature or hygrometry) or control malfunction (circuit, sensors disconnected, etc). Output normally closed when switching on	1

## Choosing the regulator for your project

### What needs to be managed?

<b>Climate</b>	<b>OR</b>	<b>Climate + Irrigation / Fertilisation</b>
		
		
<b>The complete regulator line</b>		

### How many climate zones need to be managed?

A climate zone is a growing surface area (regardless of its size) in which the required climate is the same (temperature set point for example).

**To simplify: 1 climate zone = 1 single temperature sensor**

<b>1</b>	<b>From 2 to 12</b>
	
<b>The complete regulator line</b>	

## Which functions should be managed in the zones?

Functions corresponding to a pre-defined model of Polyclim 2000 product line (on page 13) or Polyclim NG (on page 14)



Functions that are outside the Polyclim 2000 and Polyclim NG line pre-defined standards



## Calculate the number of outputs per zone

To calculate the number of outputs per zone, list your function per zone and indicate the number of outputs for each function (see table on page 9).

Then add up the total number of outputs used.

**For multizone regulation, the zone that uses the most outputs must be taken into account.**

**For example: a project with 4 climate zones**

Zone 1		Zone 2		Zone 3		Zone 4	
Roof ridge aeration x2	4	Roof ridge aeration x1	2	Roof ridge aeration x2	4	Roof ridge aeration x2	4
Shade	2	Shade	2	Heating ON-OFF	1	Shade	2
Heating ON-OFF	1	Heating ON-OFF	1	V3V heating	3	Heating ON-OFF	1
		V3V heating	3			V3V heating	3
<b>Total outputs</b>	<b>7</b>	<b>Total outputs</b>	<b>8</b>	<b>Total outputs</b>	<b>8</b>	<b>Total outputs</b>	<b>10</b>

As indicated above, the zone using the most outputs must be taken into account, in this case zone 4 with 10 outputs.

By referring to the Artic table (on page 18), we can see that the 4 zone / 16 output reference is needed



## RGAP

### TEMPERATURE CONTROLLER

Temperature controller to control hot air generator heating. 230V supply with 2 adjustable thresholds and 2 dry contact outputs (NO+NO or NO+NF).  
Supplied with a CAP0007 type temperature sensor.

RGAP with sensor  
(2 NO) CLI0050

(1 NO+1 NC) CLI0051



## CLIMTOP

### BOX FOR SIMPLIFIED VENTILATION CONTROL

Simplified ventilation control management. Built-in motor control and protection. Automatic thermostatic control  $-10 / +40^{\circ}$  (supplied) and Pulse and Deviation timer.

CLIMTOP 1 for 1 motor with thermostat  
CLI0907

CLIMTOP 2 for 2 motors with thermostats  
CLI0909







## THERMOSTAT

Thermostat,  $-10^{\circ}\text{C} / +40^{\circ}\text{C}$ , 1 reverser contact  
CLI0515



# POLYCLIM 2000 PRODUCT LINE (NOT SUPERVISED)





## POLYCLIM 2100

-  **1 side ventilation**
-  Inflation
-  Alarm
-  Internal manual mode
-  Ambient temperature sensor (supplied)

with temperature sensor  
**CLI5095**







## POLYCLIM 2150

-  **Shading screen**
-  Alarm
-  Internal manual mode
-  Watt & Lux sensor (supplied)

with Watt & Lux sensor  
**CLI5096**







## POLYCLIM 2000

-  **2 sides ventilation**
-  Inflation
-  Alarm
-  Internal manual mode
-  Ambient temperature sensor (supplied)

with temperature sensor  
**CLI5097**



## POLYCLIM 2200

-  **2 sides ventilation + 1 ridge ventilation**
-  Inflation
-  Alarm
-  Internal manual mode
-  Ambient temperature sensor (supplied)

with temperature sensor  
**CLI5098**



## SENSORS

p. 29



Temperature sensor  
**CAP0007**



Watt & Lux sensor  
**CAP0018**



Wind sensor  
**CAP0021**



Wind vane sensor  
**CAP0022**



Rain sensor  
**CAP0030**

## POWER CABINETS

p. 31



C1MA 1/1,6A  
**PUI0001**



C1MA/SA/AUTO 1/1,6A  
**PUI0005**

# POLYCLIM NG (MAX. 13 OUTPUTS)

## Adapt your Polyclim NG to your project

All Polyclim NGs have one month archiving and 4 period management.  
The 13th relay output must be the alarm.



### POLYCLIM XY - OPTION ← (See below)

1<sup>st</sup> digit = Number of vents (1 to 4)    2<sup>nd</sup> digit = without shading screen (0) or with shading screen

	Designation	Number of ventilation(s)	Shading screen	On / OFF heating	Air mixer	Inflation	Nbr of used outputs	Nbr of outputs remaining	Reference	Price
<b>1 CLIMATE ZONE</b>	POLYCLIM NG 01		X				2	10	CLI7009	
	POLYCLIM NG 10	1		X	X	X	5	7	CLI7010	
	POLYCLIM NG 11	1	X	X	X	X	7	5	CLI7011	
	POLYCLIM NG 20	2		X	X	X	7	5	CLI7020	
	POLYCLIM NG 21	2	X	X	X	X	9	3	CLI7021	
	POLYCLIM NG 30	3		X	X	X	9	3	CLI7030	
	POLYCLIM NG 31	3	X	X	X	X	11	1	CLI7031	
	POLYCLIM NG 40	4		X	X	X	11	1	CLI7040	
	POLYCLIM NG 41	4	X	X		X	12	0	CLI7041	
	POLYCLIM NG 50	5		X		X	12	0	CLI7050	

<b>MULTIZONE</b>	POLYCLIM NG 01-2Z		1 by zone				4	8	CLI7118	
	POLYCLIM NG 01-3Z		1 by zone				6	6	CLI7119	
	POLYCLIM NG 01-4Z		1 by zone				8	4	CLI7120	
	POLYCLIM NG 10-2Z	1 by zone		1 by zone	1 by zone	X	9	3	CLI7102	
	POLYCLIM NG 10-3Z	1 by zone		1 by zone		X	10	2	CLI7103	
	POLYCLIM NG 10-4Z-CH	1 by zone		1 by zone			12	0	CLI7104	
	POLYCLIM NG 10-4Z-G	1 by zone				X	9	3	CLI7105	
	POLYCLIM NG 11-2Z	1 by zone	1 by zone	1 by zone		X	10	2	CLI7110	
	POLYCLIM NG 20-2Z	2 by zone		1 by zone		X	11	1	CLI7202	

## Available options (depending on the remaining number of outputs)

Designation	Nbr of output(s)	Reference
3-way valve heating + circulator	3	CLI5500
FOG	1	CLI5503
CO2	1	CLI5504
Cooling	2 to 4	CLI5505
Clock	1	CLI5506

### SPECIFIC 4/20MA REFERENCE

Now each Polyclim NG fitted with a 4-20mA sensor will have "/420" at the end of its reference.

Example: Polyclim NG 20 + temperature / humidity sensor (CAP0024) will have CLI7020/420 as its reference

If you operate using a sensor stock, please indicate the possible presence of a 4-20mA sensor in order to properly configure your Polyclim NG inputs

**IMPORTANT: all the sensors must be 4-20mA in that case (water, pot and ambient sensors)**



# POLYCLIM NG INSTALLATION SYNOPSIS

**Weather sensors** p. 29



Temperature CAP0001

Anemometer CAP0021

2D or 360° weather vane CAP0022/25

Rain CAP0030

Watt/Lux CAP0018

**Indoor sensors** p. 28

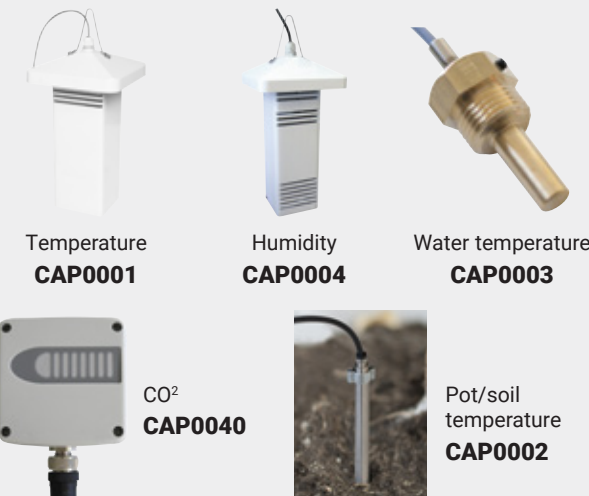

Temperature CAP0001

Humidity CAP0004

Water temperature CAP0003

CO<sup>2</sup> CAP0040

Pot/soil temperature CAP0002

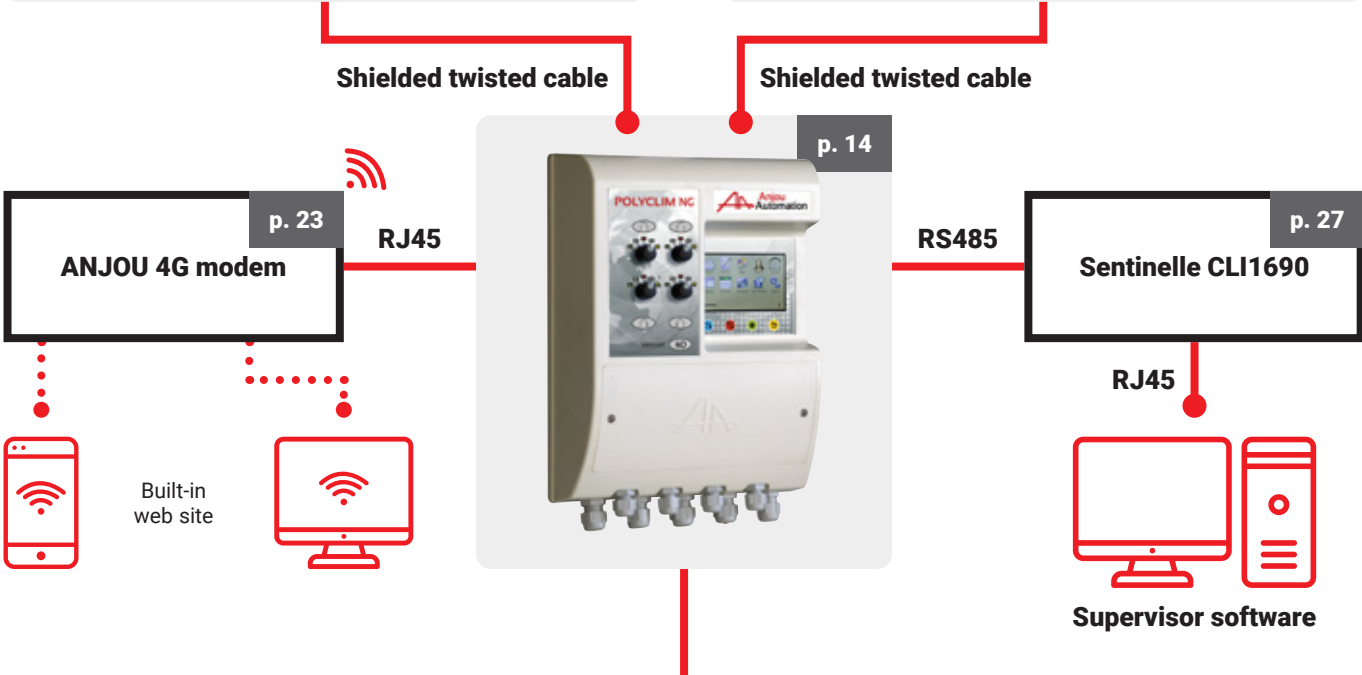

**Motor power control box** p. 30



**C1MG** p. 31



**C1MC** p. 31



**Ridge/shading gear motor** p. 36



**Side ventilation gear motor** p. 34



**Telescopic arm** p. 45



## KAIROS Regulator

The KAIROS regulator is a next generation climatic management computer. Between the Polyclim NG and the ARTIC, the KAIROS makes it possible to provide an ergonomic and cost effective solution for your multi-zone projects.

It has a colour touch screen and an embedded website providing the best browsing and the possibility of monitoring your installation remotely. Compatible with ARTIC supervision, the KAIROS is perfectly adapted to new or refurbishment projects. Its USB port can be used for easy software updates (new version, added function).

**The KAIROS is delivered in kit form ready to be fitted into your control / power cabinet.**



### CLIMATE

- From 1 to 6 climate zones with 8 (6Z), 16 (4Z) or 24 (2Z) outputs
- Full weather management
- Boiler-room module (1 boiler + 1 transport)
- External fault management: 3 standard + 16 optional

### SUPERVISION

- Compatible with ARTIC supervision
- 4G access from embedded web site (see page 22-23)

### ADVANTAGES

- Instant zone temperature and weather displays
- Easy icon access to menus and settings
- Value entry using a touch numeric keypad
- Setting backups and restores using the embedded website
- Software and configuration upgrades using a basic USB thumb drive
- Virtual manual mode: the 3 and 5 position switches for all functions are included on the screen

On its 5 inch colour touch screen, browsing through the KAIROS settings is fluid. The KAIROS includes one month of archives (alarms, events, statistics) and management of 4 periods.

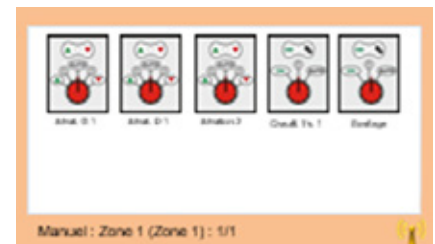
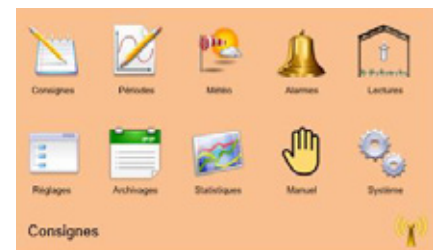

## KAIROS: CLIMATE MANAGEMENT

Climate management	8 outputs by zone CLI5808 / 01 - 06	16 outputs by zone CLI5816 / 01 - 04	24 outputs by zone CLI5824 / 01 - 02
1 zone - Ref /01	X	X	X
2 zones - Ref /02	X	X	X
3 zones - Ref /03	X	X	-
4 zones - Ref /04	X	X	-
5 zones - Ref /05	X	-	-
6 zones - Ref /06	X	-	-

## KAIROS: BOILER ROOM MANAGEMENT

Boiler room module (management of 1 boiler + 1 transport)  
CLI5835

## KAIROS: EXTERNAL FAULT MANAGEMENT

16 fault input module  
CLI1681

## KAIROS: CABINET INSTALLATION

The HMI and input/output boards are built into a sheet metal cabinet (size depending on the configuration)  
CLI5840

## KAIROS: REMOTE ACCESS

See CONNECTIVITY tab

### Web site view

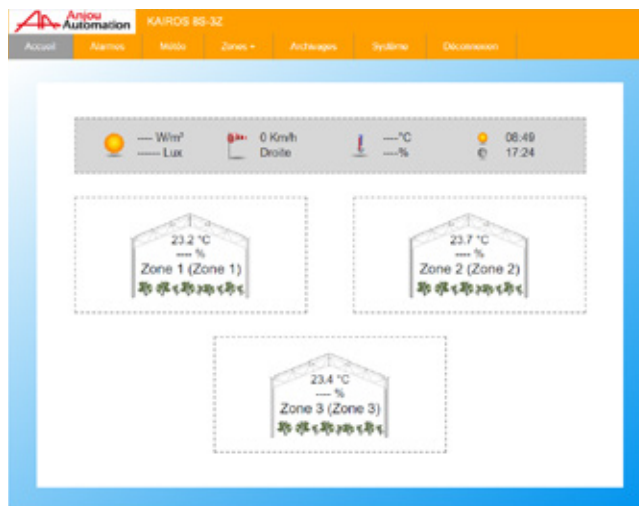



# ARTIC REGULATOR (12 X 24 OUTPUTS MAX.)

## Regulator ARTIC

The ARTIC REGULATOR is a latest generation climate and Fertilisation / Irrigation management computer. It is compatible with ANJOU AUTOMATION line sensors and can be connected to the Sentinelle ARTIC. Its wide, colour touch screen makes its configuration and the use of its data both simple and userfriendly. Its processor power makes regulation accurate and effective. Its onboard SD card makes it possible to locally store data safely for easy use. Its USB port can be used for easy software updates (new version, added function).



### CLIMATE

- From 1 to 12 zones with 8, 16 or 24 outputs
- Boiler room module (3 boilers, 3 transports, cascade, storage tank)
- Weather management

### IRRIGATION

- Up to 40 groups
- Management of 6 to 94 valves
- Management of 2 to 18 motors (master valve, pump, mixers, etc.)
- Management of 2 stations: fertilisation and clean water
- Other characteristics: identical to the NERO (see page 50)

### THE PLUSSES:

- Zone temperature, weather, station status at a glance
- Easier access to menus and settings using icons and tree structure navigation
- Value entry using a numeric keypad
- Configuration copy and restore (from one zone to another)
- Data archival (events, alarms, etc.) for an unlimited period
- 100% compatible with current supervision
- Software or configuration upgrades using a USB stick

Equipped with a 7 inch, colour touch screen, it is as easy to use as a tablet. It is fitted with SD card memory making it possible to record almost unlimited temperatures, events and alarms. Updates are very easy: just connect a USB stick.

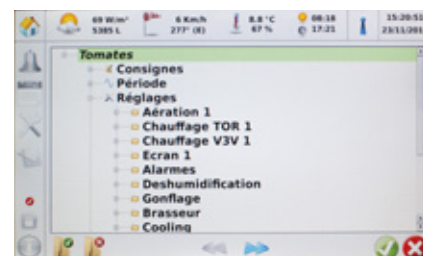
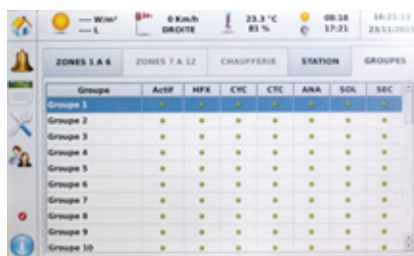

## ARTIC : CLIMATE MANAGEMENT

Climate management	8 outputs by zone CLI6308 / 01 - 12	16 outputs by zone CLI6316 / 01 - 12	24 outputs by zone CLI6324 / 01 - 12
1 zone - Ref /01			
2 zones - Ref /02			
3 zones - Ref /03			
4 zones - Ref /04			
5 zones - Ref /05			
6 zones - Ref /06			
7 zones - Ref /07			
8 zones - Ref /08			
9 zones - Ref /09			
10 zones - Ref /10			
11 zones - Ref /11			
12 zones - Ref /12			

## ARTIC : IRRIGATION MANAGEMENT

16 channels module (Valve or motors)  
**PRO1007**

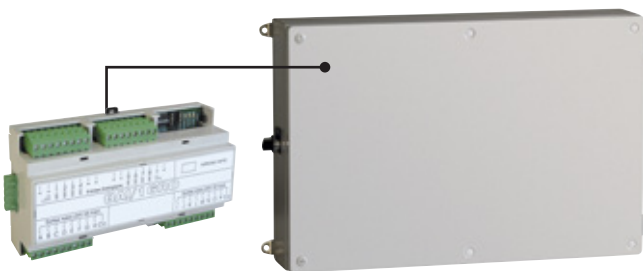

Irrigation cabinet for ARTIC  
**PRO1009**

## ARTIC : FERTILIZATION MANAGEMENT

8 channels injection module for venturi lines  
**PRO1001**

2 analogs outputs 0/10V module for fertiliser / acid / Pressure regulation  
**PRO1003**

8 dry contacts inputs / 8 analogs inputs module  
**PRO1008**

EC sensor 0/10ms with screw mounting  
**PRO1011**

PH sensor 0/10 with screw mounting  
**PRO1012**

Interface EC sensor module, digital calibration  
**PRO1013**

Interface PH sensor module, digital calibration  
**PRO1014**

Drainage (6 tanks) / pre-mixing (1 valve) module  
**PRO1015**

# ARTIC - BOILER ROOM & SUPERVISION

## ARTIC : BOILER ROOM MANAGEMENT

Boiler room module (management of 3 boilers + 3 transports)  
**CLI6035**

Boiler room + open buffer module (management of 3 boilers + 3 transports + "open buffer" type storage tank)  
**CLI6036**

## ARTIC: SUPERVISION

Artic monitoring software for a single Artic (if several Artic in supervision, see ref. CLI1690 p.27)  
**CLI1650**

### Supervision view

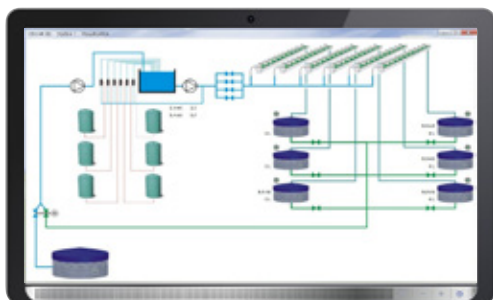
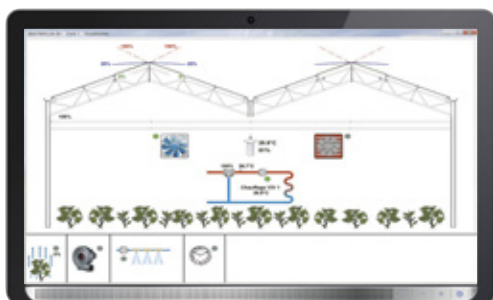
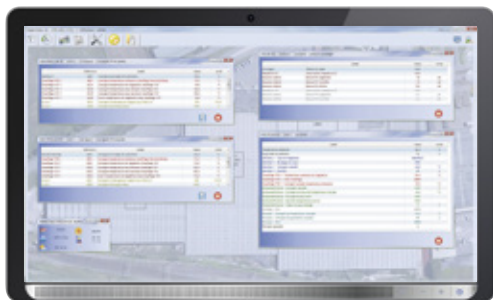

## ARTIC : EXTERNAL DEFAULT MANAGEMENT

16 fault input module  
**CLI1681**

## ARTIC : REMOTE ACCESS

See **CONNECTIVITY** tab

### Web site view

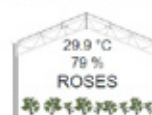
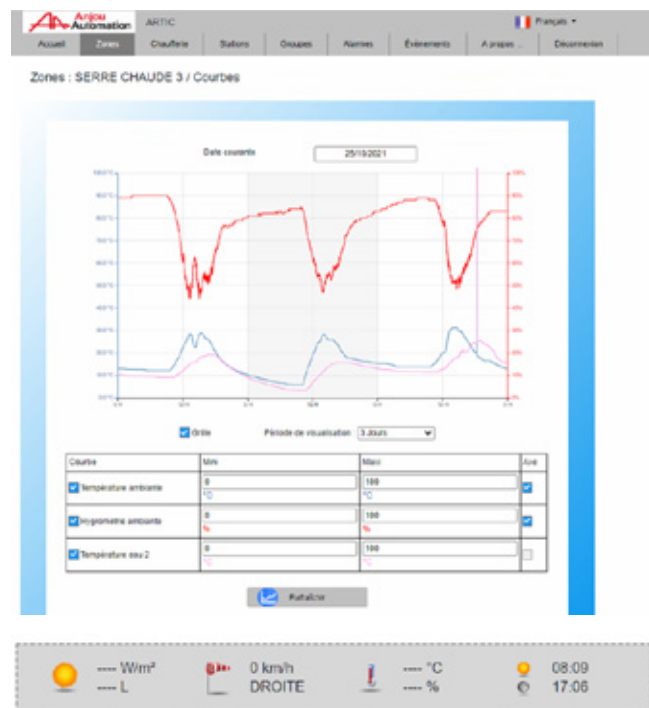





**Weather sensors** p. 29



Temperature  
**CAP0010**



Anemometer  
**CAP0021**



2D or 360°  
weather vane  
**CAP0022/25**



Rain  
**CAP0030**



Watt/Lux  
**CAP0018**

**Indoor sensors** p. 28



Temperature  
**CAP0010**



Humidity  
**CAP0004**



Water temperature  
**CAP0012**



CO<sup>2</sup>  
**CAP0040**



Pot/soil  
temperature  
**CAP0011**

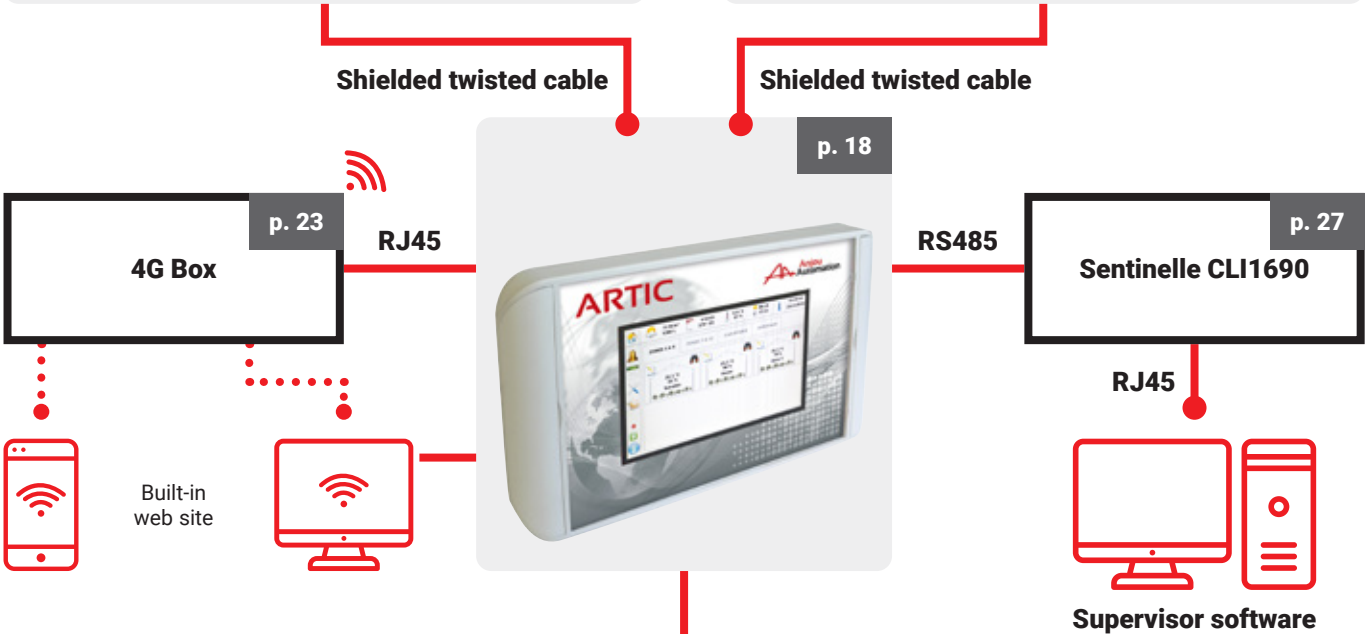

**CLIMATE** p. 30



From 1 to 12 climate zones

**FERTI-IRRIGATION** p. 49



From 14 to 94 solenoid valves,  
up to 2 stations

**BOILER ROOM** p. 20



3 boilers  
3 transports  
Open-Buffer

## Your Machine To Machine (M2M) SIM card from Anjou Data

No more headaches when choosing your M2M subscription. Anjou Data offers a SIM Card + Secure Link subscription that meets your needs for connecting to your Anjou Automation controllers.

**CLI1695**

- One-year subscription
- Tacit renewal on the anniversary date
- Offer tailored to your needs
- No need to visit a store or spend hours searching for the right subscription
- A secure link and your data protected



Your M2M subscription: [www.anjou-data.fr](http://www.anjou-data.fr)

End-user subscription

## TUTORIAL USING AN ANJOU 4G MODEM

### Step 1: SIM card



Anjou Data Subscription (see prerequisites)

### Step 2: Setting



4G modem configuration using the SIM card (see regulator doc)

### Step 3: Open VPN



Installation on PC / Smartphone / Open VPN tablet (free)

### Step 4: Customer file



Open VPN configuration using the customer file supplied by Anjou Data

## 4G BOX

- 4G access point for a single regulator. Provides the connection to the embedded website. If there is a need to access the embedded website for two or more controllers, a SIMA is required

4G BOX  
CLI1665



## SIMA: STAND-ALONE ALARM SYSTEM + 4G ACCESS

- Control box separate from the regulators and programmers
- SIMA configuration on colour touch screen and on embedded website
- Text message of alarm contact on connected regulators sent
- Possibility of connecting 48 external faults (thermostat, level measurement, circuit breaker, etc.)
- 4G access to connected regulator embedded websites
- Up to 10 users
- Priority management
- Up to 11 sequences

SIMA box  
CLI1680

16 fault input module  
CLI1681

48 défauts maximum



## REMOTE ACCESS ON PREVIOUS GENERATION CONTROLLERS

Take control of your previous-generation controllers remotely by phone, tablet or PC.



### COMPATIBLE WITH:

- OSCAR
- MASTERCLIM
- MICRORAMPE
- POLYCLIM (except 200 product line)
- IRRI 12
- MAXICLIM NG

### HARDWARE CONFIGURATION:

- ARTIC Sentinel (p.27)
- 4G BOX (p.23) + ANJOU DATA subscription



## Display supports for your regulator

FUNCTIONS	REGULATOR SCREEN	EMBEDDED WEBSITE	MONITORING
Real time sensor / probe data	X	X	X
Set point display / update	X	X	X
Alarm display and reset	X	X	X
Statistics display	Min / max value/ daily average	Min / max value/ daily average	Tables / charts
Event / alarm archival	1 month	1 month	Unlimited
Parameter import / export	-	X	X
Remote access (PC, smartphone, tablet)	-	X (subject to conditions)	X (subject to conditions)
Data extraction	-	-	X
Custom window creation	-	-	X

## Regulators with an embedded web site



POLYRAMPE



POLYPROG 12



POLYCLIM NG



ARTIC



KAIROS



NERO

## Regulator screen



## Embedded website



## Monitoring software

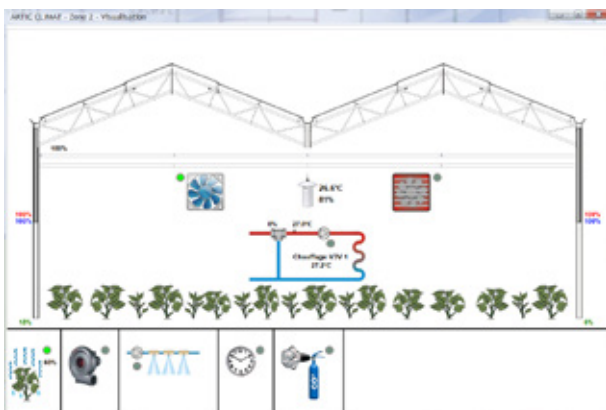



# MONITORING SYNOPTIC

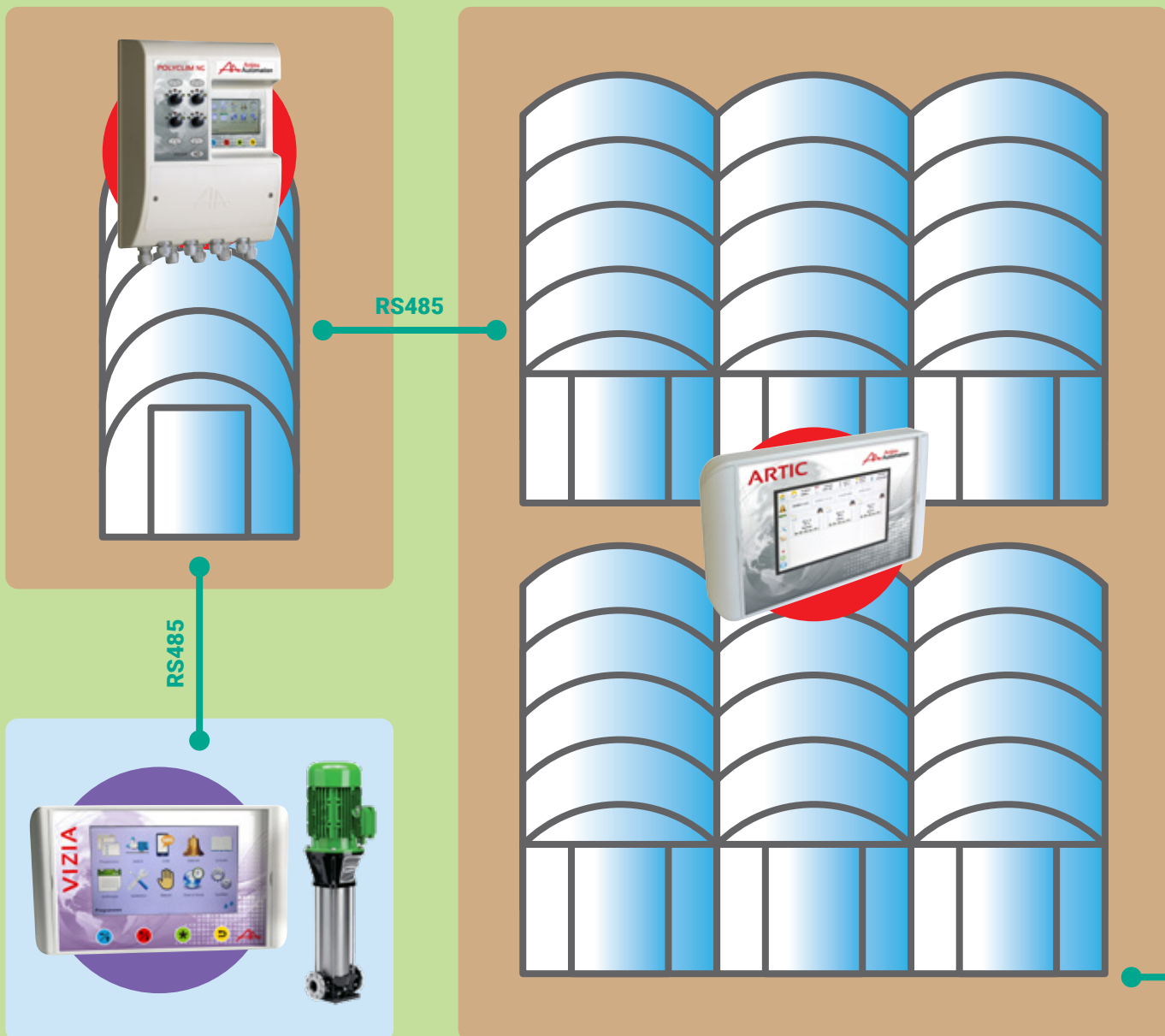

## SENTINELLE

Sentinelle is a communication gateway between the regulator networks (POLYCLIM, KAIROS, POLYRAMPE, ARTIC, NERO, VIZIA and POLYPROG 12) and the Ethernet office computer network.

In addition, it provides:

- The collection of all the settings and data from the connected regulators.
- The archival of this data locally on an SD card (without a connected computer)
- As an option: Alarm management by sending SMS messages

## MONITORING SOFTWARE

The 4G Monitoring Software (climate and irrigation) enables:

- A real time overview of the installation. The latter can be customised for each site.
- The display and modification of the settings for the connected regulators.
- The real time viewing of the measurements from the different sensors, the regulations statuses, etc. in summary or table format...
- The use of the data recorded by Sentinelle (measurements, events) in the form of graphs, chronograms or tables.
- The creation and use of windows allowing the display and update of the most commonly used settings.
- Settings backup and restore.
- Settings copies.
- Multi-user management.
- As an option: the alarm system settings.

# MONITORING SYNOPTIC

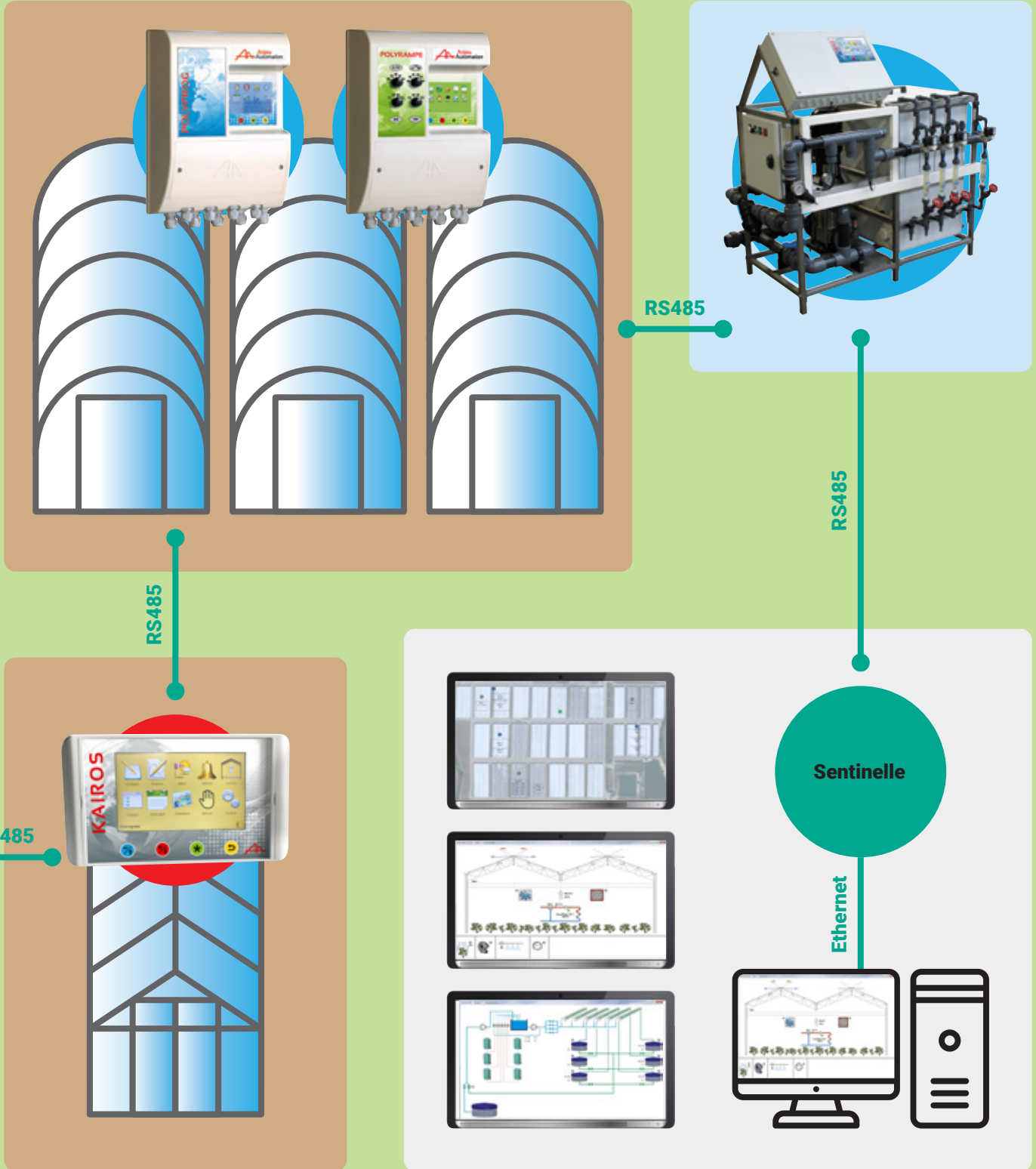

CONNECTIVITY

## SENTINELLE BOX

SENTINELLE + supervision software  
CLI1690

## WEB SUPERVISION AND ALARM ACCESS

4G Box  
CLI1665

# INSIDE SENSORS

## AMBIENT TEMPERATURE, HUMIDITY AND COMBINED SENSOR

Ambient temperature sensor, type NTC 5kOhms  
**CAP0001**

Ambient temperature sensor type 4-20 mA  
**CAP0010**

Relative humidity sensor, 4 / 20 mA output  
**CAP0004**

Ambient temperature + humidity sensor, PT 100 / 2 x 4-20mA type  
**CAP0024**



## WATER PROBE

Water temperature probe, type CTN 5kOhms  
**CAP0003**

Water temperature applise probe, type CTN 5kOhms  
**CAP0003.A**

Water temperature probe, type PT 100 / 4-20 mA  
**CAP0012**

Water temperature applise probe, type PT 100 / 4-20 mA  
**CAP0012.A**



**CAP0003.A**



**CAP0003**

## POT / SOIL PROBE

Pot / soil probe, type CTN 5kOhms  
**CAP0002**

Pot / soil probe, type PT 100 / 4-20 mA  
**CAP0011**



## CO<sup>2</sup> SENSOR

- Range 0 - 5000 ppm
- 4-20 mA output
- For use in greenhouses or breeding farms

**CAP0040**



## CERBERE MODULE

- Inclinator in watertight enclosure for accurate and reliable measurement of greenhouse vent opening angles. Secured rapidly by 2 screws directly to the vent structure – no adjustment, no wear. Replaces copy potentiometers. 2-wire 4-20 mA output signal (others on request). Adjustable measurement range - 55° to +55°

4/20 mA output  
**CAP0060**



## SUNLIGHT & LUMINOSITY SENSOR

### Watt/m<sup>2</sup> sunlight sensor

- Range 0-1500 W/m<sup>2</sup>, 4/20 mA output

**CAP0013**

### Luminosity (lux) sensor

- Range 0-100 KLux, 4/20 mA output

**CAP0017**

### Watt/m<sup>2</sup> + Lux sensor - 2 x 4/20 mA outputs

- Range 0-1500 W/m<sup>2</sup> / 0-100 KLux

**CAP0018**



## WIND VANE SENSOR

- Wind vane sensor, 2 directions

**CAP0022**

- 0-360° wind vane, 4/20 mA output

**CAP0025**



## INCLINED RAIN SENSOR

- Rain sensor, carbon cell, 1 dry contact (0.5 A under 24 V)

**CAP0030**



## WIND SENSOR

- Wind speed sensor, 2-wire frequency output

**CAP0021**



## RAIN GAUGE

- Mesures rainfall in mm
- Accuracy of 0,2 mm
- Dry contact output

**CAP0026**



# MOTOR BOXES

## C1MA

### SINGLE-MOTOR AUTOMATIC MODE POWER UNIT

- Unit providing power interface for control of 1 ventilation motor or screen
- Inversor contactor + circuit breaker, limit switch management
- 24 VAC control unit
- Power: 400 V, 3-phase (others on request)

C1MA 1/1,6A

PUI0001

C1MA 0,6/1A

PUI3003



## C2MA

### POWER BOXES: 2 AUTOMATIC MODE MOTORS

- Power interface control box to control 2 ventilation motors or screen motors
- Inverter contactors + circuit breakers, limit switch management
- 24Vac control
- Power: 400 V TRI (others on request)

C2MA 1-1,6A

PUI3043

C2MA 0,6-1A

PUI0014



## C1MA / SA

### SINGLE-MOTOR MANUAL MODE UNIT

- Unit providing power interface for local control of 1 motor
- Inversor contactor + circuit breaker, limit switch management
- Control in local mode only: Open / Off / Close
- Power: 400 V, 3-phase (others on request)

C1MA / SA 1/1,6A

PUI0004

C1MA / SA 0,6/1A

PUI3013



## C2MA/SA

### POWER BOXES: 2 MANUAL MODE MOTORS

- Power interface control box to control 2 ventilation motors or screen motors
- Inverter contactors + circuit breakers, limit switch management
- 24Vac control
- Power: 400 V TRI (others on request)

C2MA/SA 1-1,6A

PUI3053

C2MA/SA 0,6-1A

PUI0027



## C1MA / SA / AUTO

### SINGLE-MOTOR MANUAL AND AUTOMATIC MODE UNIT

- Unit providing power interface for control of 1 ventilation motor or screen in local switched mode or remotely (as for C1MA).
- Inversor contactor + circuit breaker, limit switch management
- 24 VAC remote control unit
- Power: 400 V, 3-phase (others on request)

C1MA / SA / AUTO 1/1,6A

PUI0005

C1MA / SA / AUTO 0,6/1A

PUI3023



## C2MA/SA/AUTO

### POWER BOXES: 2 MANUAL AND AUTOMATIC MODE MOTORS

- Power interface control box to control 2 ventilation motors or screen motors
- Inverter contactors + circuit breakers, limit switch management
- 24Vac control
- Power: 400 V TRI (others on request)

C2MA/SA/AUTO 1-1,6A

PUI3063

C2MA/SA/AUTO 0,6-1A

PUI0028





## MONO/TRI BOX

### SINGLE-PHASE POWER SUPPLY BOX

- Power interface control box for ventilation or screen motor control
- Contactor + circuit breaker, limit switch management
- Local control for SA & SA/AUTO versions
- Box for single-phase 220v power supply

**C1MA MONO/TRI  
PUI0016**

**C1MA/SA MONO/TRI  
PUI0017**

**C1MA/SA/AUTO MONO/TRI  
PUI0018**



For your 220V single-phase electric installations

Compatible with all Anjou Automation gear motor ranges

## AABFR SINGLE OR THREE-PHASE

### SIMPLIFIED INFLATION MANAGEMENT FOR SINGLE OR THREE-PHASE INFLATION TURBINE

- AABFR single or three-phase: simplified inflation management for single or three-phase inflation turbine
- Built-in circulator circuit breaker and contactor
- Adjustable pulses and intervals
- Integrated manual operation

**MONO 230VAC  
CLI0906**

**TRI + N 400VAC 0,4/0,6A  
CLI0905**



## 3WV + PUMP

### POWER INTERFACE CONTROL BOX FOR A CIRCULATION PUMP AND A 3-WAY VALVE

- Power interface control box for a circulation pump and a 3-way valve
- Pump controlled by circuit-breaker + contactor, 3-way valve output either 24VAC or 230VAC. 2 selectors for manual / automatic commands
- Automatic command input using a dry contact, 24VDC or 24VAC

**3WV + PUMP  
PUI0009**



## C1M C

### INTERFACE UNIT FOR 1 HOT AIR GENERATOR

- Unit providing power interface between heating control and heater
- Connected in place of thermostat
- 24 VAC remote control only - Dry contact relay output

**C1MC  
PUI0003**



## C1M G

### POWER UNIT FOR 1 INFLATION TURBINE

- Unit providing power interface for control of inflation turbine
- Contactor + circuit breaker
- Low-voltage, 24 VAC control unit
- Power: 400 V, 3-phase (others on request)

**C1MG 0,4/0,6A  
PUI0002**

**C1MG 0,25/0,4A  
PUI3031**



# POWER CABINET

## MODULAR CABINETS



- Power interface control box for inflation fan control
- Contactor + circuit breaker
- 24Vac control
- Power: 400 V TRI (others on request)

1 motor cabinet  
**PUI0301**

2-motor cabinet  
**PUI0302**

3-motor cabinet  
**PUI0303**

4-motor cabinet  
**PUI0304**

5-motor cabinet  
**PUI0305**

6-motor cabinet  
**PUI0306**

7-motor cabinet  
**PUI0307**

8-motor cabinet  
**PUI0308**

9-motor cabinet  
**PUI0309**

10-motor cabinet  
**PUI0310**

11-motor cabinet  
**PUI0311**

12-motor cabinet  
**PUI0312**

## INDUSTRIAL CABINETS

### Custom cabinet

Thanks to an equipped wiring workshop, Anjou Automation is capable of meeting your specific electric cabinet requirements for sectors such as:

- Greenhouse climatic management
- Agricultural irrigation
- Drainage
- Miscellaneous automation

From creating the wiring diagram to wiring the cabinet, we propose a turnkey solution for your electric project

Compliant with applicable standards, our cabinets can be delivered with one of our regulators embedded in the facade.

Please contact us directly for any request for information or quotations



A specific request? Contact us!

# MISSI RANGE

## MISSI

- Three phased motor control module controlled by the power line. 200-500V three phased 50-60Hz power supply
- Motor output 3A max category Ac53a. 2 "open - close" limit switch inputs.
- MISSI combines the limit switch inputs with the power supply phase rotation.
- **Elimination of remote control cables, gear motor safety limit switches and phase checking relays.**

### MISSI + circuit breaker in a control box PUI0708

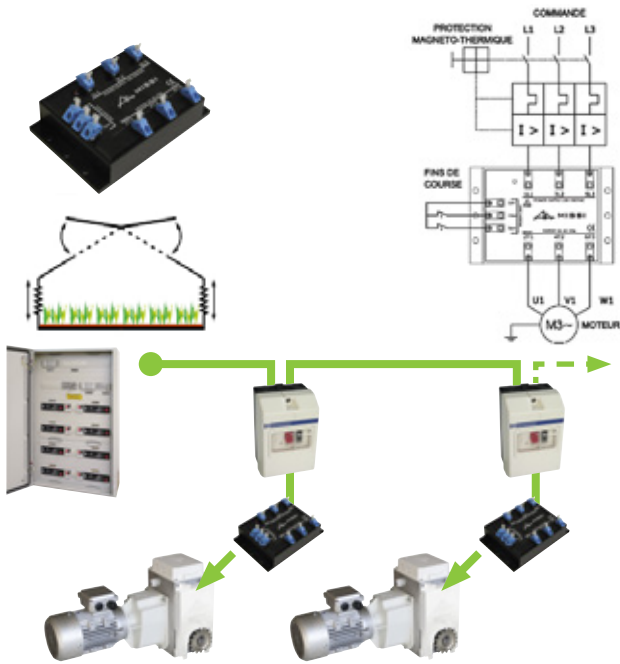

## MISAMP

- Three phased inverter module. 200 - 500V 50-60Hz power supply. Motor output 3A max category Ac53a.
- 24Vac remote control on 3 wires (common, open, close)
- Fitted with a current check on the motor line, it can cut the control if there is an overload (winder jam,...).
- 2 "open - close" limit switch inputs
- **It can eliminate the winder motor limit switches (depending on the installation configuration).**

### MISAMP only PUI0500

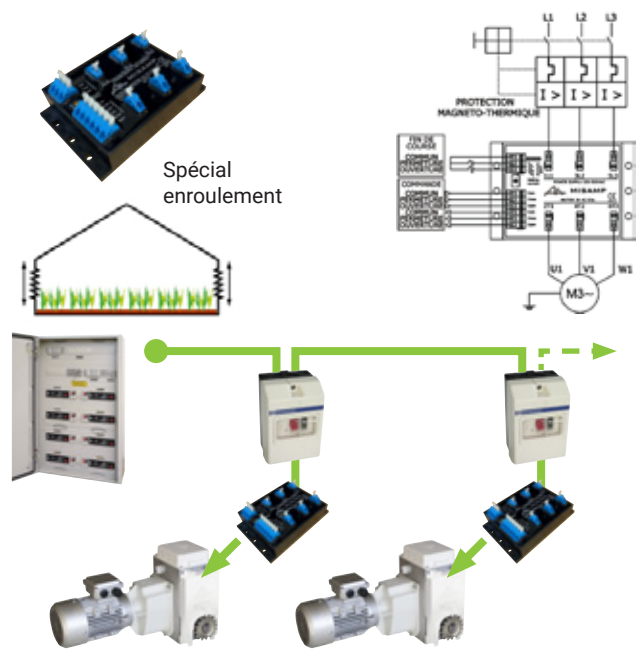

## MISSI LS

- Three phased motor control module controlled by the power line. 200-500V three phased 50-60Hz power supply
- Motor output 3A max category Ac53a. 2 inputs for an inclinometer sensor with magnetic detection for "limit switch" management.
- MISSI LS combines the values measured by the inclinometer sensor with the power supply phase rotation.
- The "open limit switch" is set using 2 rotating switches (100 possible positions) to set the maximum angular position.
- The "close limit switch" is set by adjusting the magnet position on the greenhouse frame.
- **Elimination of remote control cables, gear motor limit switches and phase checking relays.**

### MISSI LS + magnet + sensor in a control box PUI0707

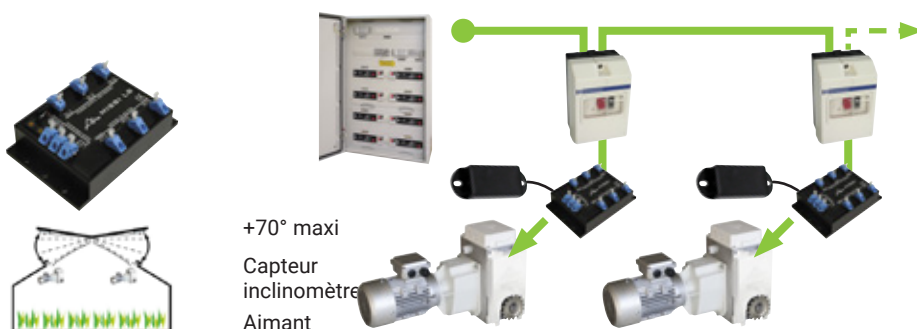

## MISSI RANGE

- Built into the Anjou Automation gear motor
- Pre-wired between the limit switch and the motor UVW and MISSI terminals

### MISSI option MEC1160



### MISSI LS option MEC1163



### MISAMP option MEC1162



# GEAR MOTORS FOR ROLL-UP VENTILATION

A line of gear motors to mechanise all your roll-up ventilation on your tunnel and multi-span greenhouses using telescopic arms.

## ANJOU LIGHT DRIVE (ALD)

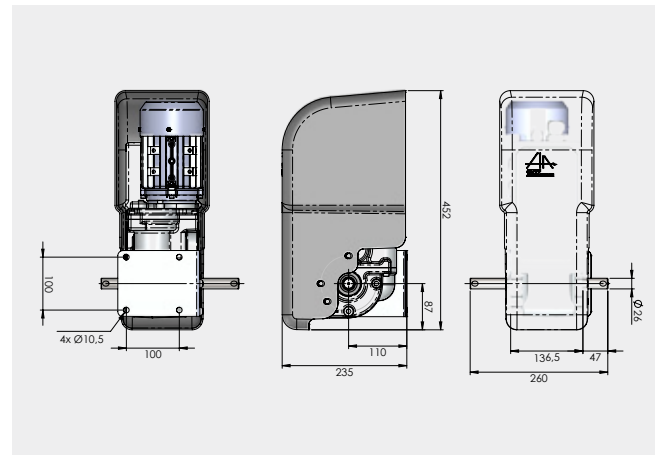
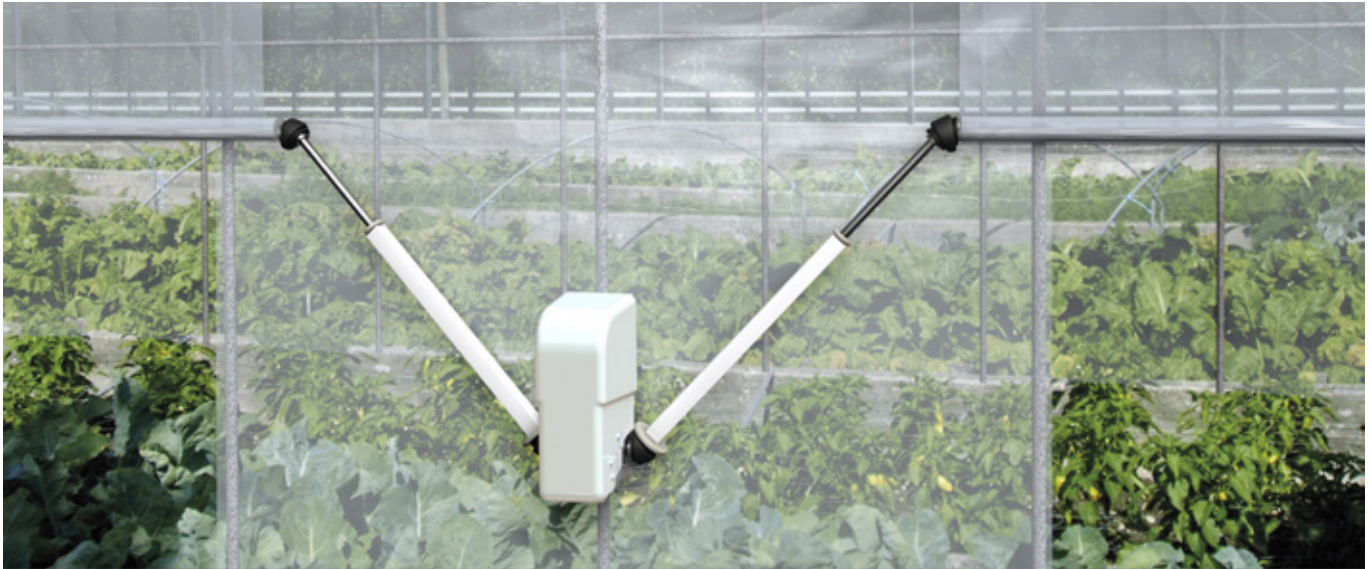

Reference	Torque	Rotation speed	Power	Current at 3 x 400V / 50HZ at 3 x 460V / 60HZ	Current at 3 x 230V / 50HZ at 3 x 280V / 60HZ	Weight	Price
<b>MEC1300</b>	160 Nm	5 TR / Min	0,25kW	0,9A	1,6A	14kg	



# GEAR MOTORS FOR ROLL-UP VENTILATION

## ANJOU ORIGINAL DRIVE (AOD)

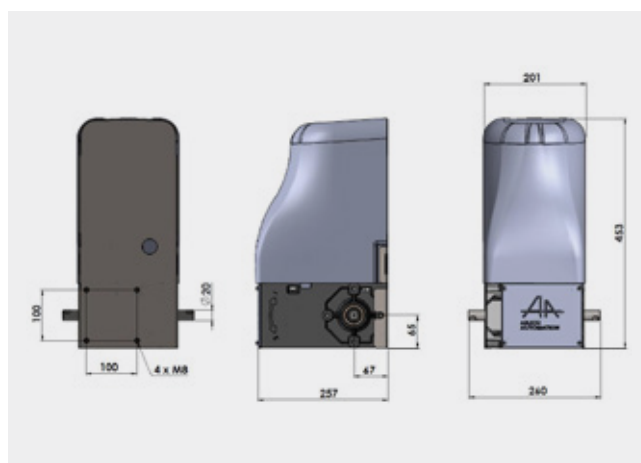

Reference	Torque	Rotation speed	Power	Current at 3 x 400V / 50HZ at 3 x 460V / 60HZ	Current at 3 x 230V / 50HZ at 3 x 280V / 60HZ	Weight	Price
<b>MEC1200</b>	160 Nm	5 TR / Min	0,25kW	0,9A	1,6A	22kg	
<b>MEC1201</b>	160 Nm	5 TR / Min	0,25kW	0,9A	1,6A	22kg	





# GEARMOTOR FOR ROOF VENTILATION AND SHADING

A line of gear motors to mechanize all your ridge vents and/or motorize your shading system.

## ANJOU LIGHT DRIVE (ALD)



### DESCRIPTION:

- Sealed construction in aluminium casing
- Non reversible load
- Manual backup operation on electric motor
- No-tool adjustable limit switch
- Phase inversion check (If MISSI option)
- 33 rotation working stopper stroke for vents and 100 rotations for shade
- Ø32 or Ø34 tubular chain coupling
- Two possible fixtures: side and back
- Silent running
- Housing provided to add the MISSI AA line

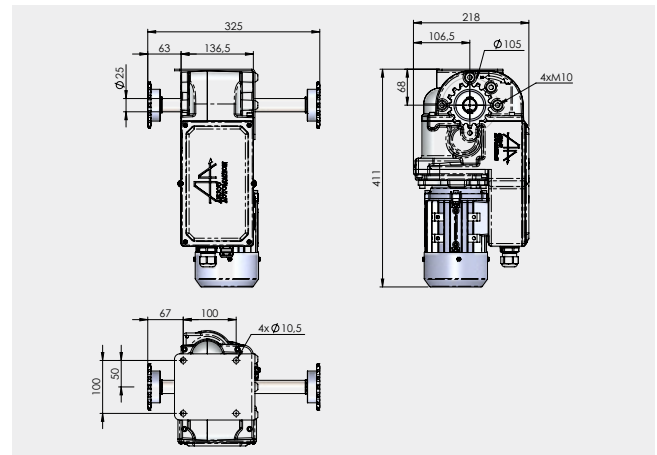
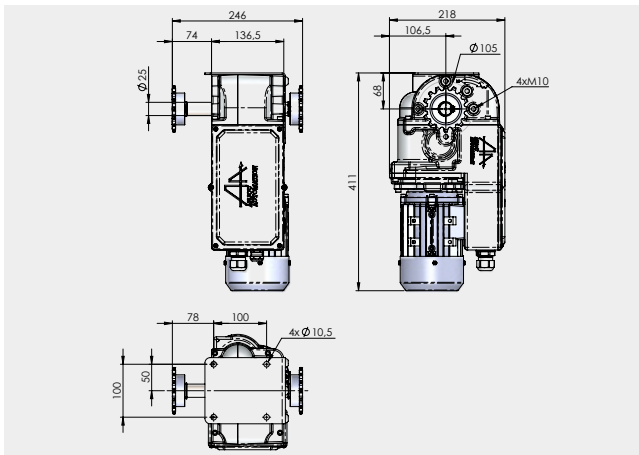

Reference	Torque	Rotation speed	Power	Current at 3 x 400V / 50HZ at 3 x 460V / 60HZ	Current at 3 x 230V / 50HZ at 3 x 280V / 60HZ	Weight	Large version reference	Price
<b>MEC1510-32/34</b>	280 Nm	2,8 TR / Min	0,25kW	0,9A	1,6A	14kg	<b>MEC1510L-32/34</b>	
<b>MEC1511-32/34</b>	160 Nm	5 TR / Min					<b>MEC1511L-32/34</b>	

# GEARMOTOR FOR ROOF VENTILATION AND SHADING

## ANJOU ORIGINAL DRIVE (AOD)

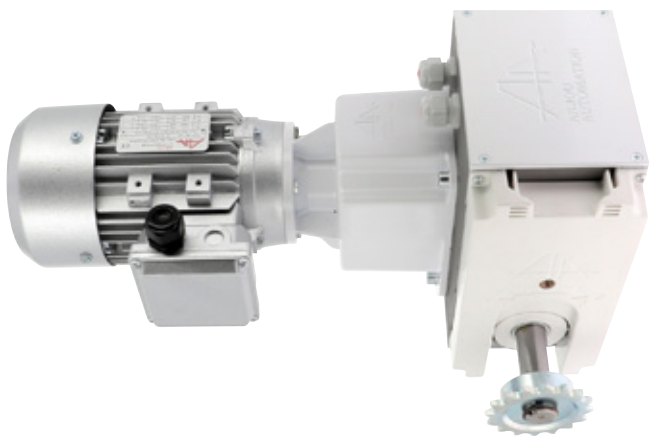

### DESCRIPTION:

- Sealed construction in aluminium casing
- Non reversible load
- Manual backup operation on electric motor
- No-tool adjustable limit switch
- Phase inversion check (If MISSI option)
- 33 rotation working stopper stroke for vents and 100 rotations for shade
- Ø32 or Ø34 tubular chain coupling
- Two possible fixtures: side and back
- Silent running
- Housing provided to add the MISSI AA line

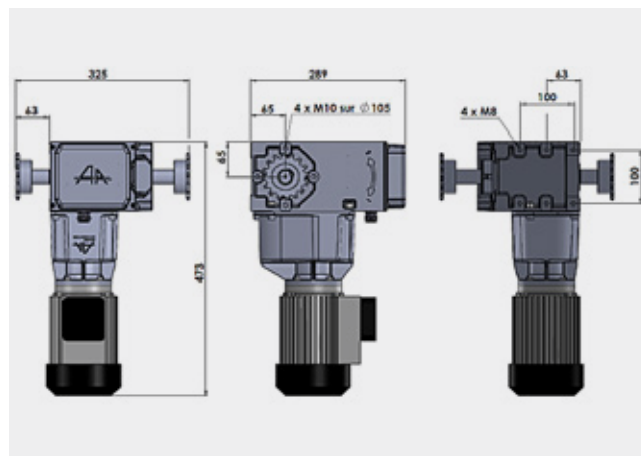
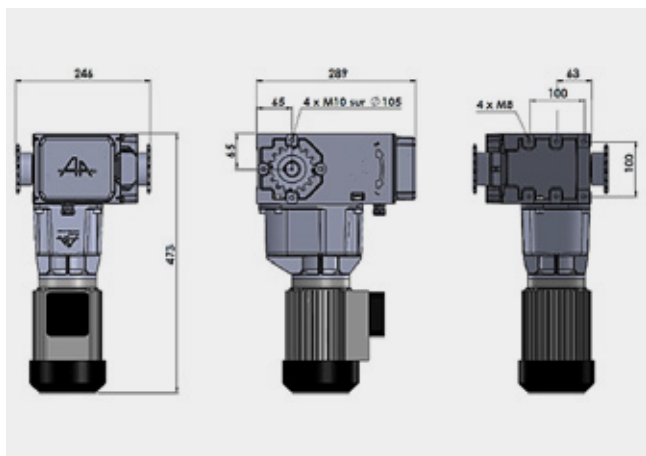

Reference	Torque	Rotation speed	Power	Current at 3 x 400V / 50HZ at 3 x 460V / 60HZ	Current at 3 x 230V / 50HZ at 3 x 280V / 60HZ	Weight	Large version reference	Price
<b>MEC1400-32/34</b>	400 Nm	2,8 TR / Min	0,37kW	1,1A	1,9A	24kg	<b>MEC1400L-32/34</b>	
<b>MEC1401-32/34</b>	400 Nm	1,8 TR / Min	0,25kW	0,9A	1,6A	24kg	<b>MEC1401L-32/34</b>	
<b>MEC1402-32/34</b>	350 Nm	5 TR / Min	0,55kW	1,5A	2,6A	24kg	<b>MEC1402L-32/34</b>	
<b>MEC1403-32/34</b>	250 Nm	2,8 TR / Min	0,25kW	0,9A	1,6A	24kg	<b>MEC1403L-32/34</b>	
<b>MEC1404-32/34</b>	200 Nm	2,8 TR / Min	0,25kW	0,9A	1,6A	24kg	<b>MEC1404L-32/34</b>	
<b>MEC1405-32/34</b>	550 Nm	2,8 TR / Min	0,55kW	1,5A	2,6A	24kg	<b>MEC1405L-32/34</b>	
<b>MEC1406-32/34</b>	240 Nm	2,8 TR / Min	0,37kW	1,1A	1,9A	24kg	<b>MEC1406L-32/34</b>	
<b>MEC1407-32/34</b>	160 Nm	2,8 TR / Min	0,25kW	0,9A	1,6A	24kg	<b>MEC1407L-32/34</b>	



# GEARMOTOR ON TROLLEY

## ANJOU LIGHT DRIVE (ALD)

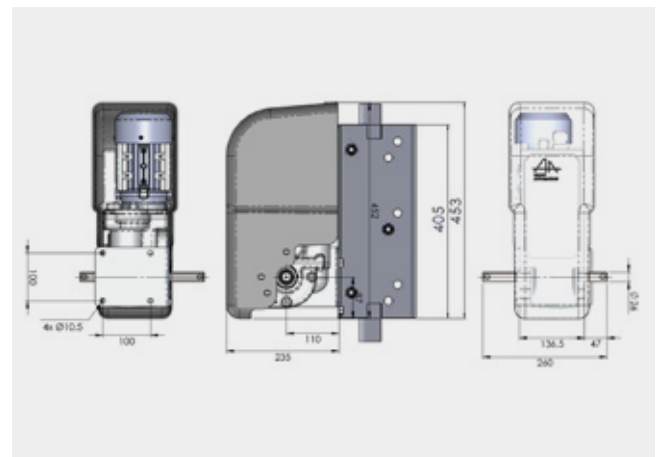

Reference	Torque	Rotation speed	Power	Current at 3 x 400V / 50HZ at 3 x 460V / 60HZ	Current at 3 x 230V / 50HZ at 3 x 280V / 60HZ	Output shaft for	Weight	Price
<b>MEC1313</b>	160 Nm	5 TR / Min	0,25kW	0,9A	1,6A	Round tube 1"	19kg	

# GEARMOTOR ON TROLLEY

## ANJOU ORIGINAL DRIVE (AOD)

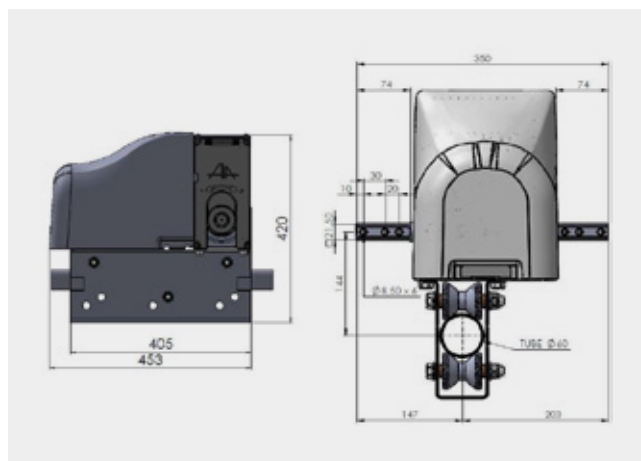
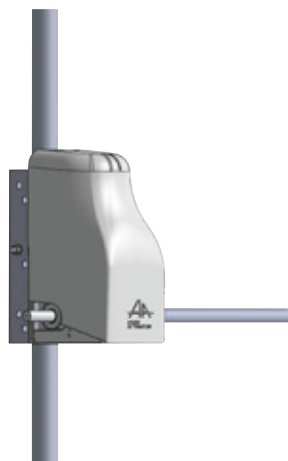

Reference	Torque	Rotation speed	Power	Current at 3 x 400V / 50HZ at 3 x 460V / 60HZ	Current at 3 x 230V / 50HZ at 3 x 280V / 60HZ	Output shaft for	Weight	Price
<b>MEC1211</b>	160 Nm	5 TR / Min	0,25kW	0,9A	1,6A	Square tube 25 x 25 x 1.5 or round tube Ø32mm	18kg	
<b>MEC1213</b>						Square tube 25 x 25 x 2		





# SHADE SPREADER GEAR MOTORS

## ANJOU LIGHT DRIVE (ALD)

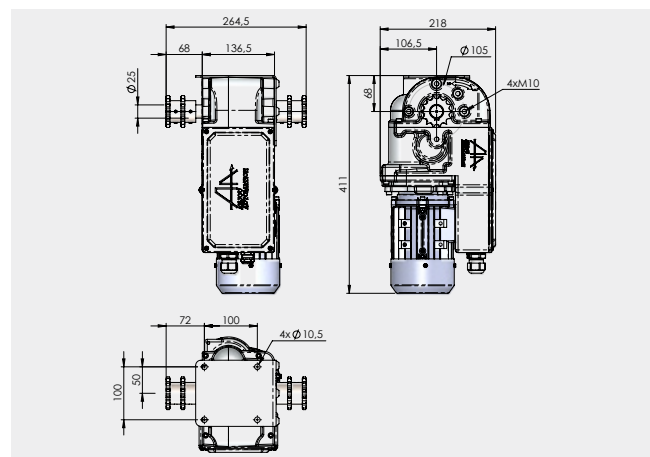

Reference	Torque	Rotation speed	Power	Current at 3 x 400V / 50HZ at 3 x 460V / 60HZ	Current at 3 x 230V / 50HZ at 3 x 280V / 60HZ	Weight	Description	Price
<b>MEC1551</b>	280 Nm	2,8 TR / Min	0,25kW	0,9A	1,6A	14kg	Simple spreader	
<b>MEC1550</b>							Double spreader	



# SHADE SPREADER GEAR MOTORS

## ANJOU ORIGINAL DRIVE (AOD)

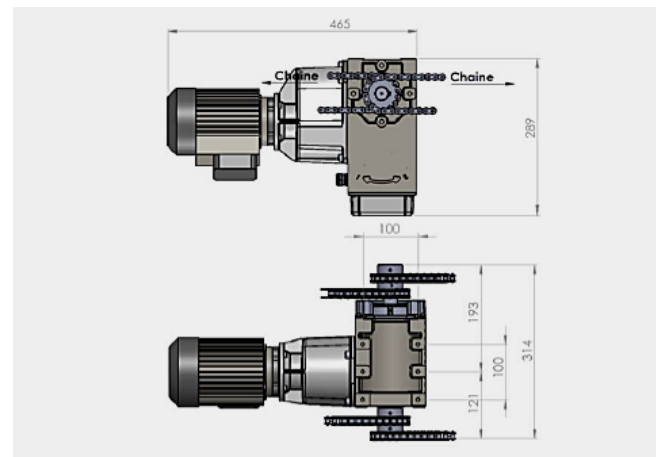
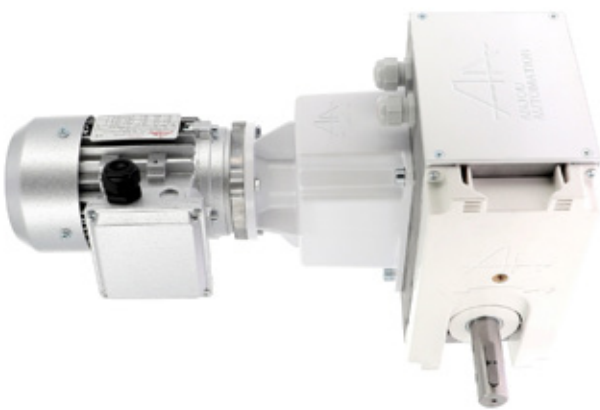

Reference	Torque	Rotation speed	Power	Current at 3 x 400V / 50HZ at 3 x 460V / 60HZ	Current at 3 x 230V / 50HZ at 3 x 280V / 60HZ	Weight	Description	Price
MEC1451	300 Nm	1,8 TR / Min	0,25kW	0,9A	1,6A	24kg	Simple spreader	
MEC1450							Double spreader	



# MANUAL GEARS

## ANJOU MANUAL DRIVE (AMD)

### Manual gears for roll-up ventilation

A line of reducing gear to mechanise all your roll-up ventilation on your tunnel and multi-span greenhouses. This reducing gear can be operated manually or using a hand-held power tool (not included).

#### DESCRIPTION:

- Non reversible transmission under load
- Sealed motor on bearings in a white lacquered aluminium casing with top-up lubrication
- Stainless steel drive shaft
- Manual operation using a crank handle (depending on the model)
- Operation using a hand-held power tool (depending on the model)

### ROLLING WITH TELESCOPIC ARM



Reference	Reduction	Maneuver	Position	Input shaft Ø for	Output shaft Ø for	Max winding length Ø32	Max winding length Ø60	Price
MEC0100	1/8	cranck	static	20mm	telescopic arm MEC0001 to MEC0008	75m	50m	
MEC0101	1/16	cranck				90m	65m	
MEC0105	1/23	screwer H17				140m	90m	

### DIRECT ROLLING ROUND TUBE



Reference	Reduction	Maneuver	Position	Input shaft Ø for	Output shaft Ø for	Max winding length Ø32	Max winding length Ø60	Price
MEC0120	1/8	cranck	mobile	26mm	tube 1"	75m	50m	
MEC0121	1/16					90m	65m	
MEC0125	1/23					140m	90m	

### DIRECT ROLLING ON A CART



Reference	Reduction	Maneuver	Position	Input shaft Ø for	Output shaft Ø for	Max winding length Ø32	Max winding length Ø60	Price
MEC0161	1/8	cranck	mobile	For 1" tube junction	tube 1"	60m	35m	
MEC0160	1/23	screwer 18V 400tr/mn max or Crankshaft				100m	55m	

### DIRECT ROLLING SQUARE TUBE



Reference	Reduction	Input shaft Ø for	Output shaft Ø for	Max winding length Ø32	Max winding length Ø60	Price
MEC0122	1/8	21,5 x 21,5mm	tube 25 x 25 x 1,5mm	75m	50m	
MEC0123	1/8	20,5 x 20,5mm	tube 25 x 25 x 2mm	75m	50m	
MEC0124	1-16			90m	65m	
MEC0126	1/23			140m	90m	

# MANUAL GEARS

## FACADE ROLLING



Reference	Reduction	Maneuver	Position	Input shaft Ø for	Output shaft Ø for	Max rolling height	Max winding length Ø60	Price
MEC0140	1/4	cranck	mobile		tube 1" and tube 25 x 25 x 1,5mm		35m	
MEC0144	1/4	cranck	mobile	Built-in crankshaft	tube 1" and tube 25 x 25 x 1,5mm	0,8m	35m	
MEC0141						2,5m		
MEC0142						3,5m		
MEC0143						4,3m		

## SPREADER



Reference	Reduction	Maneuver	Position	Input shaft Ø for	Output shaft Ø for	Max winding length Ø32	Max winding length Ø60	Price
MEC0102	1/23	cranck fitted with a hook	static					
MEC0152								

## HALF MOON AND GUILLOTINE VENTILATION. HATCH AND FOOD CHAIN (BREEDING)



Reference	Reduction	Maneuver	Position	Input shaft Ø for	Output shaft Ø for	Max winding length Ø32	Max winding length Ø60	Price
MEC0103	1/23	cranck fitted with a hook	static	fitted with a hook	tube 1"	100m	55m	
MEC0104								

## ANGLE TRANSMISSION



Reference	Reduction	Maneuver	Position	Input shaft Ø for	Output shaft Ø for	Max winding length Ø32	Max winding length Ø60	Price
MEC0300	1/1	right	static	junction tube 1"	telescopic arm			
MEC0302		left			telescopic arm			
MEC0301		right			tube 1"			
MEC0303		left			tube 1"			



# MANUAL GEARS ACCESSORIES

## CRANK



Reference	Type	Extremity	For reducer	Dimension	Price
MEC0203	Crankshaft	tubular for 1" tube	MEC0120/0121/0123/0160	size 0,45m	
MEC0207		tubular for 25x25x1,5' tube	MEC0122		
MEC0210	cranck	fitted with a hook	MEC0102/0103/0104	sleeve size 1,10m	
MEC0211				sleeve size 1,50m	
MEC0212				sleeve size 2,00m	
MEC0213				sleeve size 2,50m	
MEC0214	cranck	fitted with a hook	MEC0102/0103/0104	sleeve size 0,60m	
MEC0201	cranck		MEC0102/0103/0104/152/105		
MEC0202	cranck		MEC0100/101		
MEC0200	ring		MEC0152/0102/0103/0104		

## SLEEVE



Reference	Reducer	Type	Extremity	For reducer	Price
MEC0025		sleeve	Ø28	MEC0001 to MEC0006	
MEC0027			Ø26		
MEC0026		sleeve	25 x 25 x 1,5	MEC0001 to MEC0006	
MEC0035			25 x 25 x 2		
MEC0028		sleeve	Ø60	junction Ø26	
MEC0036		sleeve	Ø55	MEC0141 to MEC0144	
MEC0130		sleeve	Ø26	MEC0120/0121	
MEC0131		sleeve	25 x 25 x 1,5	MEC0120/0121	
MEC0134			25 x 25 x 2		
MEC0132	1/23	Screw kit	H27	MEC0109/0160/0124/0125/0126	
MEC0133		Cart		MEC0109	

# TELESCOPIC ARMS

## Telescopic arms for roll-up ventilation

ANJOU AUTOMATION proposes that you use this mechanism to make operating your roll-up ventilation on your tunnel and multi-span greenhouses easier. These telescopic arms can be operated manually or automatically depending on your requirements.

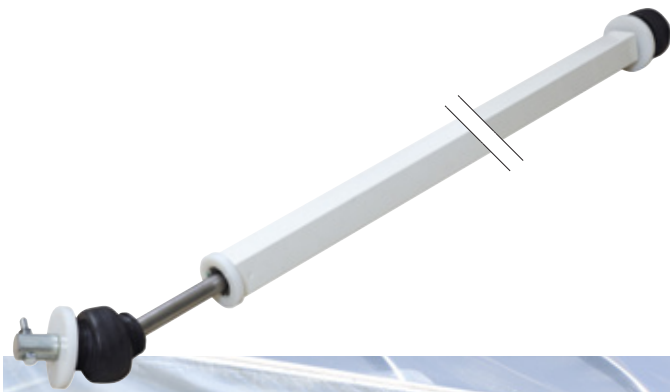

### DESCRIPTION:

- winding height up to 4.20m,
- Output Stem stainless steel
- Aluminum Tube white lacquered high resistance
- Improved sealing with specific joints
- No sharp corners to preserve your plastics and nets

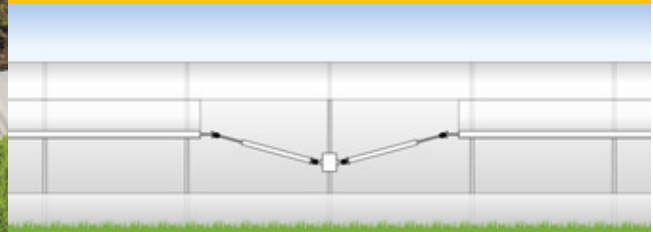

Reference	Max rolling height	Max Ø32 single double rolling length	Max Ø60 single double rolling length	Max Ø60 tube double rolling length	Length closed	Length open	Price
MEC0001	1,40 m	125 m	75 m	45 m	0,90 m	1,10 m	
MEC0002	2,00 m	125 m	75 m	45 m	1,10 m	1,45 m	
MEC0003	2,40 m	125 m	75 m	45 m	1,30 m	1,90 m	
MEC0004	2,40 m	125 m	75 m	45 m	1,50 m	2,40 m	
MEC0005	2,40 m	125 m	75 m	45 m	2,10 m	2,60 m	
MEC0006	2,40 m	125 m	75 m	45 m	2,10 m	3,20 m	



Reference	Entry tip	Exit tip	Input shaft Ø for	Thickness flat bar	Drive	Price
MEC0030	Round	Round	20 mm		2 cones male / female at 180°	
MEC0031	Flat bar	Round	20 mm	14 mm		
MEC0032	Flat bar	Flat bar		14 mm		





# IRRIGATION CART MANAGEMENT

## POLYRAMPE

- 230V power supply
- Up to 10 solenoid outputs
- 0-100% speed adjustment
- Front, back and safety limit switch input
- Metering input (sectorisation) encoder / plot
- Variable drive fault input
- Manual mode using the switches on the front
- 1 communication bus to the variable drive
- 1 Ethernet port
- 1 embedded web site for programming and manual mode from a mobile support

**PRO0270**



**ONLY COMPATIBLE WITH THE VARIABLE DRIVE BOX BELOW**

## VARIABLE DRIVE BOX

- 1 main switch 2 x 10
- 1 N+6A circuit breaker
- 1 ATV12 0.37kW variable drive
- 1 Marked connection terminal block
- 1 set of cable glands

**Box to be installed next to the irrigation cart motor**

**PRO0271**



## NANORAMPE NG

- 4 speeds available for moving the watering boom
- Control of a watering solenoid valve
- Automatic return cycle with watering
- Manual mode (without watering)

**PRO0216**

Devices intended for the management of watering booms. Controls a three-phase 230V motor to move the boom.

# SELECTION GUIDE

**ANJOU AUTOMATION** proposes several ranges of programmers and watering computers for professional use. All these products have been developed on the basis of producers' requirements.

## POLYPROG 12

- 12 to 48 channel electronic programmers
- Color-touch screen
- Upgraded manual function
- Time or percentage irrigation
- Embedded website



**Applications: greenhouses, hydroponic culture, fertiliser injection and EC/pH monitoring, technical applications**

## MICROFERTI

- Controller for simplified fertilisation management, 3 fertilisers and 1 acid, EC and pH monitoring, alarms.
- Very easy to use.



**Applications: greenhouses, hydroponic culture, fertiliser injection and EC/pH monitoring, technical applications**

## NERO

- 6- to 96-channel computer
- "Super programmer" or "Irri-Ferti station" version
- Compact and user-friendly (large graphic screen)
- 6 fertilisers and 40 groups
- Switch on each channel, remotable modules, time or volume management, integrated reports,
- SENTINELLE compatible



**Applications: greenhouses, hydroponic culture, fertiliser injection and EC/pH monitoring, technical applications**

## ANJOU FERTIL DIRECT

- Anjou Fertil is a direct injection station (venturi), using the network pressure, with flow rates ranging from 3 to 20 m<sup>3</sup>/h.

Available in four versions:

- 3 up to 6 m<sup>3</sup>/hr
- 6 up to 9 m<sup>3</sup>/hr
- 9 up to 15 m<sup>3</sup>/hr
- 15 up to 20 m<sup>3</sup>/hr



## ANJOU FERTIL BAC DE MELANGE

- The ANJOU FERTIL mixing tank station is an injection power station with a venturi and mixing tank system, for flow rates from 2 to 30m<sup>3</sup>/hr.



## ANJOU FERTIL BYPASS

- ANJOU FERTIL BY PASS STATION: Direct injection system especially adapted to high flow rates (20 to 100m<sup>3</sup>/h).

Available in version:

- 3 to 100m<sup>3</sup>/hr. Consult us.



# POLYPROG 12 - MICROFERTI

## POLYPROG 12

- 12 standard solenoid valves with extension possible up to 48
  - Pump/motor relay control.
  - Possibility of managing 8 extra pumps
  - 12 irrigation groups
  - 3 irrigation stations available
  - 1 pause input to suspend irrigation
  - Management of a Solar meter
  - 6 analogue inputs: 3 temperature and 3 hygrometry / tensiometer
  - Management of 3 dry contact inputs
  - Up to 12 valves operated simultaneously
  - Manual start up of a group
  - Independent time per valve
- Setting of valve times to the second
  - Sequential programming
  - Filling, irrigation and rinsing step.
  - Group start up modes:
    - Set time
    - Cyclical
    - Calendar
    - Solar meter
    - Dry contact
    - Analogue
    - Safety

### PRO1280



## EXTENSION POLYPROG 12

1st extension module -12 channels, relay output to switch from 12 to 24 channels, supplied in a box with a 24Vac transformer

### PRO1220

Following extension module, 12 channel relay outputs (maximum 48 channels per POLYPROG 12 programmer)

### PRO1221

Control module - 8 motors / fertilisation channels

### PRO1222

## MICROFERTI

### MICROFERTI : BOWED CONTROLLER FOR SIMPLIFIED FERTILIZATION CONTROL

- Control of 3 fertilizers and 1 acid with EC and pH sensors (Venturi version)
- Control starting on 2 ON/OFF inputs (2 groups of set points)
- Control of EC/pH alarms : one alarm relay
- 1 pump relay output
- Digital calibration of the EC/pH sensors. An easy device to use, especially suitable for small installations.
- Fully equipped box + EC/pH transmitters + EC sensor + pH sensor

#### MicroFerti

### PRO1020

0-10V interface for controlling 2 variable speed metering pumps

### PRO1003

Option : Solar meter, change in EC in relation to sunshine (CAP0013)



## ANJOU FERTIL DIRECT

### STATION OF DIRECT INJECTION FERTILIZERS / ACID

ANJOU FERTIL station is a central injection of fertilizer / acid for the conduct of the fertilization in hydroponic culture. Venturi-based technology, it uses the pressure of the existing network and allows flow rates ranging from 3 to 20m<sup>3</sup> /h. It has two basic lines of injection (fertilizer or acid) and locations for 2 additional lines are available. ANJOU FERTIL can host MICROFERTI or OSCAR controllers and their probes to ensure control of the conductivity (fertilizer) and pH (acid) effectively. From simple installation and reduced maintenance, ANJOU FERTIL comes in 4 versions depending on the flow capacity of the installation:

- 3 to 6 m<sup>3</sup>/h
- 6 to 9 m<sup>3</sup>/h
- 9 to 15 m<sup>3</sup>/h
- 15 to 20 m<sup>3</sup>/h

Direct station 3-6 m<sup>3</sup>/h, 2 lines of injection (without controller)  
**STD0001**

Direct station 6-9 m<sup>3</sup>/h, 2 lines of injection (without controller)  
**STD0002**

Direct station 9-15 m<sup>3</sup>/h, 2 lines of injection (without controller)  
**STD0003**

Line of additional injection  
**STD0010**

Suction strainer  
**STD0015**



**AnjouFertil**  
Direct →

## ANJOU FERTIL BAC DE MÉLANGE

### FERTILISER / ACID INJECTION STATION WITH MIXING TANK

The ANJOU FERTIL station is a fertiliser / acid injection station for the management of hydroculture crop fertilisation. Based on the Venturi technology and fitted with a 225 litre mixing tank, it allows flow rates from 2 to 30 m<sup>3</sup>/h. As standard it has 3 injection lines (2 fertiliser + 1 acid) and positions for 2 additional lines are available. ANJOU FERTIL allows the use of the OSCAR controller as well as its probes in order to provide efficient EC (fertiliser) and pH (acid) conductivity regulation. Frame extension for premixing valve and priming pump



**AnjouFertil**  
Bac de mélange →

Contact us

## ANJOU FERTIL BY PASS

### SPECIAL LARGE FLOW DIRECT INJECTION SYSTEM

The AnjouFertil By-Pass station is a direct injection station specially suited for large flows. ANJOU FERTIL allows the use of the OSCAR controller as well as its probes in order to provide efficient EC (fertiliser) and pH (acid) conductivity

Available in versions:

- From 3 to 100 m<sup>3</sup>/h. Contact us.



**AnjouFertil**  
By-Pass →

Contact us

## NERO

The NERO is a next generation fertilisation-irrigation management computer. An upgrade from the OSCAR, it has kept the use logic while including additional functions.

It has a colour touch screen and an embedded website providing the best browsing and the possibility of monitoring your installation remotely. Compatible with SENTINELLE, the NERO is perfectly adapted to new or refurbishment projects. Its USB port can be used for easy software updates (new version, added function).

In its superprogrammer or fertilisation computer configuration, the NERO can also be directly installed on your fertilisation frames.



### FERTILISATION-IRRIGATION

- From 14 to 94 solenoid valves
- Management of up to 4 fertilisation stations (2 standard + 2 optional)
- Management of 8 static outputs for injection lines or 4 0-10V dosing pumps
- Up to 40 irrigation groups

### SUPERVISION

- Compatible with SENTINELLE
- Embedded website via 4G access (see page 22-23)

### THE ADVANTAGES

- Station status display,
- Easy icon menu and setting access
- Value entry using a numeric keypad
- Setting backup and restore using the embedded website
- Software and configuration upgrades using a basic USB thumb drive
- Virtual manual mode: AUTO/0/MANUAL switches for the solenoid valves included on the screen

On its 5 inch colour touch screen, browsing through the NERO settings is fluid. The NERO includes one month of archives (alarms, events, statistics).

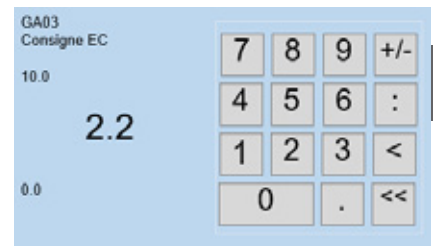
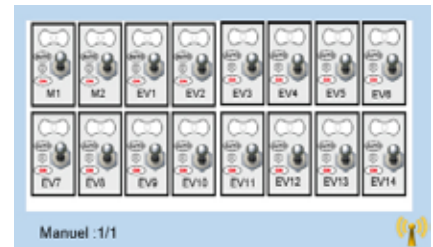
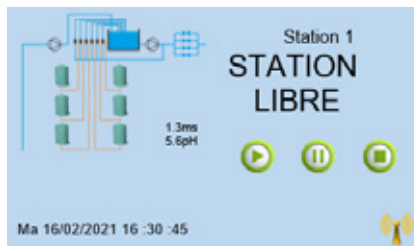
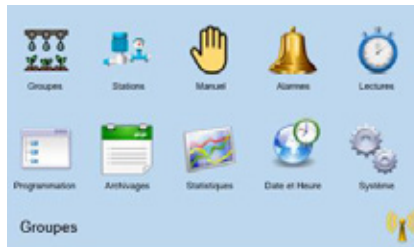



## NERO: FERTI-IRRIGATION MANAGEMENT

Complete control box for 16 channels (2 motors + 14 valves)  
**PRO1400**



Irrigation / Ferti station module, 1 board, 8 inputs/ 8 outputs "Venturi version"  
**PRO1001**

Irrigation / Ferti station module, 1 board, 2 outputs 0 / 10 V (1 acid / 1 fertiliser)  
**PRO1003**

Module with 16 additional channels  
**PRO1007**

8 dry contacts inputs / 8 analogs inputs module  
**PRO1008**

Drainage / pre-mixing module  
**PRO1015**

Soil moisture sensor 4/20 mA  
**PRO1016**

EC sensor, 0-10 mS / cm, screw mounting, excl. Mounting  
**PRO1011**

pH sensor, 0-10, screw mounting, excl. Mounting  
**PRO1012**

Interface EC sensor module, digital calibration  
**PRO1013**

Interface PH sensor module, digital calibration  
**PRO1014**

Paddlewheel Flow Sensors + support DN50  
**STD0051**

### FUNCTIONS

- Up to 40 groups
- Control of 6 to 94 valves
- Control of 2 to 18 motors (mastervalue, pump, stirrers, etc)
- Control of 2 stations (standard) + 2 optional
- Simultaneous or sequential valve control
- Watering by time or by volume, valve optimisation module
- Starting at static times, cyclically or by date
- EC and pH control:
  - Control of 6 fertilisers + 1 acid in the "venturi" version
  - Or control of up to 3 fertilisers and 1 acid in the "variable speed pump" version
  - Change to the EC according to the solarmeter
- Control of a mixing tank (filling, pre-mixing, and sunlight, draining)
- Alarm management
- Forced operation switches on every output (automatic / 0 / manual)
- Balance module with saving over 4 weeks
- Drainage and pre-mixing options available

## NERO: REMOTE ACCESS

See **CONNECTIVITY** tab

Web site view



## NERO: ADDITIONAL STATIONS

2 additional stations managed by the NERO  
**PRO1410**

## Pumping control cabinets with network flow and pressure regulation

These three devices are used to start up pumping and monitor the network. They inform you of any incident arising on the installation.

- Managed by controller with parameter setting via screen and front panel keypad.
- Extremely user-friendly, easy access to all parameters.
- Integrated link with variable speed drive, parameter adjustment from controller.



### MONOPUMP MANAGEMENT

- Pressure management using a variable speed drive control on the pump motor
- Variable flow rate management to stop the pump
- Start using a set point or a remote control using a text message
- Alarm threshold management
- Management of 3 programmes: set points, thresholds, etc

### MULTIPUMP MANAGEMENT

- Pressure or flow management using a variable master pump with the addition of 1 to 6 static or variable pumps.
- Flow management to trigger and stop the pumps
- Minimum pressure maintained using a Jockey pump
- Other features identical to the Monopump version

### GSM MODEM OPTION FOR VARIO'POMPE NG

- Remote start and stop control
- Modification of pressure setpoints
- Reading of the operating status (pressure value, motor data)
- Management of alarms

### COMPLETE KIT FOR MONOPUMP MANAGEMENT (VIZIA + VARIABLE SPEED DRIVE + PRESSURE SENSOR + GSM MODEM)

Cabinet 3kW - 7,2A max  
**APR0100**

Cabinet 4kW - 10A max  
**APR0101**

Cabinet 5,5kW - 13A max  
**APR0102**

Cabinet 7,5kW - 16A max  
**APR0103**

Cabinet 11kW - 24A max  
**APR0104**

Cabinet 15kW - 32A max  
**APR0105**

Cabinet 18kW - 37A max  
**APR0106**

Cabinet 22kW - 44A max  
**APR0107**

Cabinet 30kW - 61A max  
**APR0108**

Cabinet 37kW - 73A max  
**APR0109**

Cabinet 45kW - 90A max  
**APR0110**

Cabinet 55kW - 106A max  
**APR0111**

Cabinet 75kW - 147A max  
**APR0112**

Cabinet 90kW - 177A max  
**APR0113**

Cabinet 110kW - 212A max  
**APR0114**

Cabinet 132kW - 260A max  
**APR0115**

Cabinet 160kW - 315A max  
**APR0116**



VIZIA  
+



4-20mA pressure sensor  
+



GSM modem

+

Variable speed drive  
Delivered next to the cabinet  
(IP55)



=

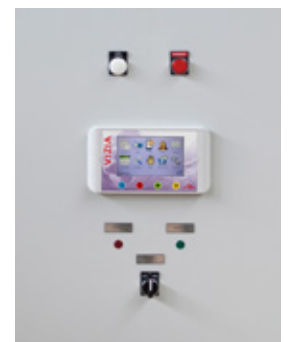

Built into a sheet metal cabinet

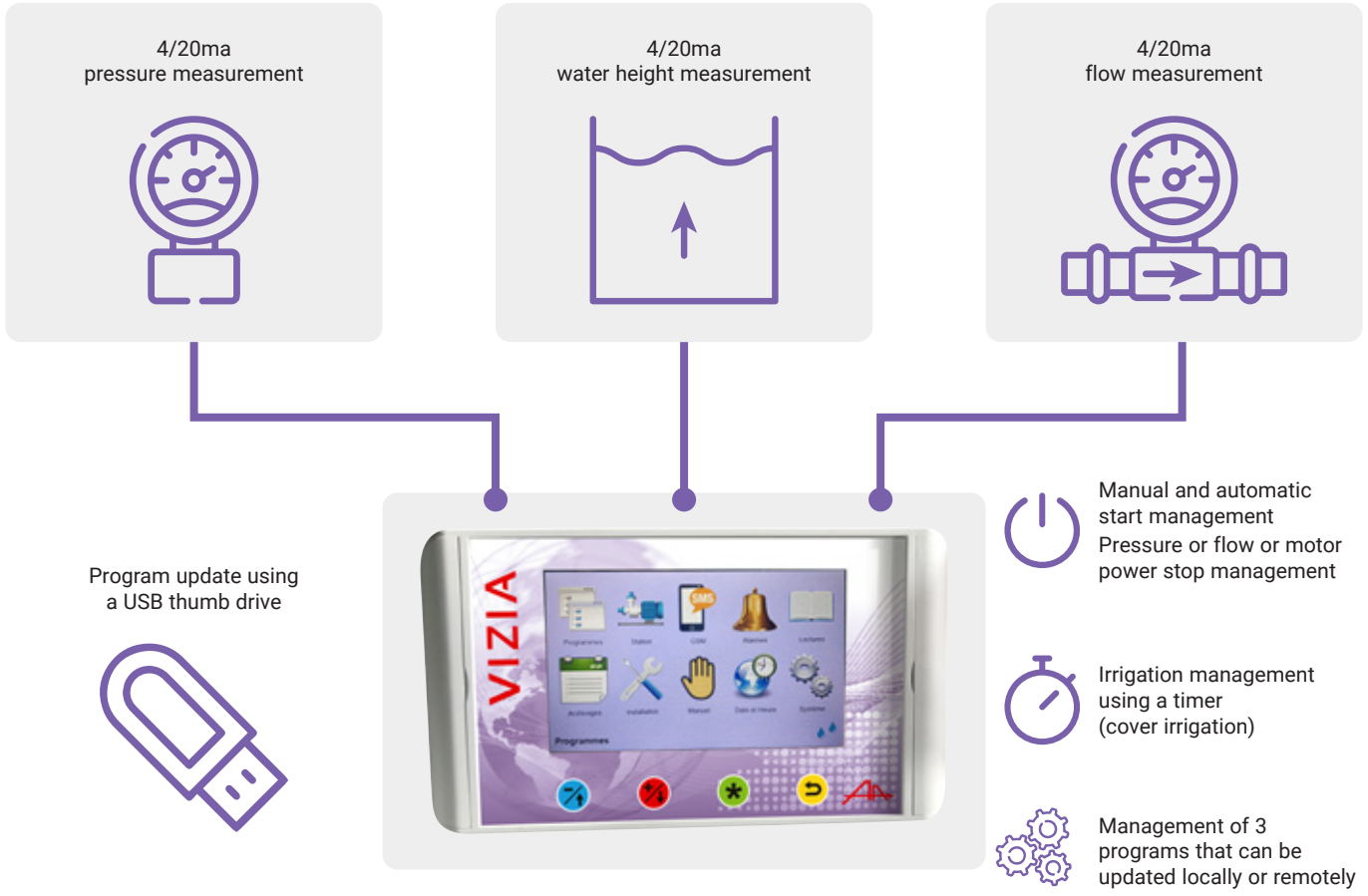

Management of 1 to 7 pumps (1 to 7 pumps on variable drives)  
Management of 1 jockey pump (static or variable)  
Management of 1 priming pump

Management of pressure - flow level - pump fault, etc. alarms

Contact output reporting level 3 threshold, flow thresholds, alarms, current program.  
RJ45 port to read and backup settings using an embedded website

**Using GSM 3G/4G modem**  
Start and stop program change  
Alarm reset  
Irrigation network and motor data reading  
Management of up to 10 users

- Remote access embedded website option
- Management of all VIZIA settings, configuration backup
- 2-year subscription (M2M SIM card not included) CLI1662

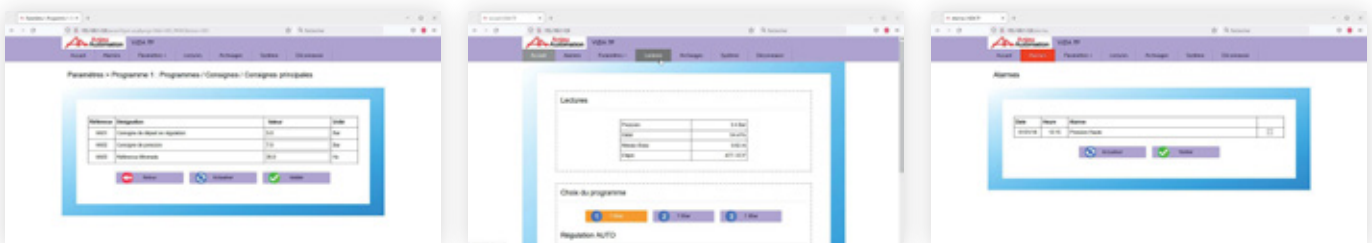

# DIRECT / PROGRESSIVE START-UP



## PUMP START-UP UNITS POMPY NG

Electromechanical version, 1 to 15 kW, robust build, no electronics

- Voltage surge protection
- AUTO/OFF/MANUAL function
- Remote control input
- Fault display

### Options:

- Run-dry
- Flow rate and pressure
- Safety devices
- Gradual starter

### DIRECT

POMPY NG 2,2kW - 5A max  
**IRI0300**

POMPY NG 4kW - 9A max  
**IRI0301**

POMPY NG 5,5kW - 12A max  
**IRI0302**

POMPY NG 7,5kW - 16A max  
**IRI0303**

POMPY NG 11kW - 25A max  
**IRI0304**

POMPY NG 15kW - 32A max  
**IRI0305**

### PROGRESSIVE

POMPY NGDP 2,2kW - 5A max  
**IRI0310**

POMPY NGDP 4kW - 9A max  
**IRI0311**

POMPY NGDP 5,5kW - 12A max  
**IRI0312**

POMPY NGDP 11kW - 25A max  
**IRI0313**

POMPY NGDP 15kW - 32A max  
**IRI0314**

## POMPY OPTIONS

Run-dry detection by electrodes  
**IRI0330**

HP/LP safety timeout  
**IRI0332**

LP filtering timeout  
**IRI0334**

Flow switch unpriming timeout  
**IRI0336**

Clock  
**IRI0338**

Timer  
**IRI0340**

32 A master switch  
**IRI0342**

# ACCESSORIES

## PRESSURE SWITCHES

- For high or low pressure safety system

Pressure switch 10-30 bars  
**IRI0070**

Pressure switch 4-17 bars  
**IRI0071**

Pressure switch 1-10 bars  
**IRI0069**



## PRESSURE SWITCH WITH POINTER

- Weatherproof, moulded aluminium case, diameter 114 mm.
- Measurement display and 2 adjustable thresholds on dial.
- Output on 2 changeover contacts, measuring 0/25 bar.

Pressure switch with pointer 0/25b  
**IRI0072**



## ELECTRODE LEVEL GAUGE

- Inox

Electrode level gauge  
**IRI0085**



## MICRO START

### START-UP ITEM (STATOR / STAR-TRIANGLE)

- Adjustable startup timer
- Adjustable pressurisation time
- High and low pressure safety system management
- Integrated remote control
- LED mimic panel (faults, startup, LP, HP)

Automate Start  
**IRI0103**



## ALIM START

### 400/24VAC POWER SUPPLY UNIT

- Protection by fuse + integrated varistors

Power supply ALST15  
**IRI0105**



# CABINETS WITH PROGRESSIVE START-UP

## CABINETS WITH PROGRESSIVE START-UP

Cabinet with progressive start-up. Management with an automaton which ensure the HP / BP security. Avoids "water hammers" and prolongs the service life of the facilities

Cabinet with progressive start-up 15kW - 32A max  
**APR0001**

Cabinet with progressive start-up 22kW - 47A max  
**APR0002**

Cabinet with progressive start-up 30kW - 62A max  
**APR0003**

Cabinet with progressive start-up 37kW - 75A max  
**APR0004**

Cabinet with progressive start-up 45kW - 88A max  
**APR0005**

Cabinet with progressive start-up 55kW - 110A max  
**APR0006**

Cabinet with progressive start-up 75kW - 140A max  
**APR0007**

Cabinet with progressive start-up 90kW - 170A max  
**APR0008**

Cabinet with progressive start-up 110kW - 210A max  
**APR0009**

## OPTIONS FOR PROGRESSIVE START-UP CABINETS

No-flow shutdown

**IRI0049**

Voltmeter

**IRI0054**

Unpriming

**IRI0050**

40 A differential switch

**IRI0056**

24-hour timer

**IRI0051**

63 A differential switch

**IRI0057**

24-hour clock

**IRI0052**

Resistor safety device

**IRI0058**

Time counter

**IRI0053**

Threshold ammeter

**IRI0067**







880 rue Léo Baekeland - B.P. 57  
85290 Mortagne-sur-Sèvre - FRANCE  
Tél. 02 51 63 02 82 - Fax 02 51 63 02 83  
[contact@anjouautomation.fr](mailto:contact@anjouautomation.fr)



[www.anjouautomation.com](http://www.anjouautomation.com)

ANJOU AUTOMATION - S.A.S. au capital de 7 067 666 €  
880 RUE LÉO BAEKELAND - B.P. 57 - 85290 MORTAGNE-SUR-SÈVRE  
RCS LA ROCHE-SUR-YON 834 108 375 - N° TVA CEE - FR 35834108375