

MEC1402-34

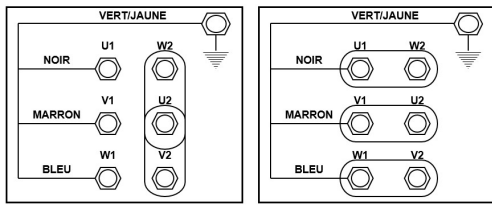

Opening/shading motorisation + Ø34 chain couplings



Raccordement de la plaque à bornes
400V TRI 230V TRI



Ø34 tubular chain
coupling: MEC1101

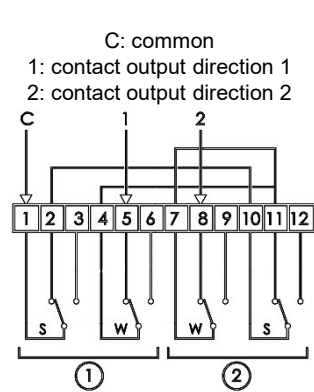

Limit switch wiring
diagram

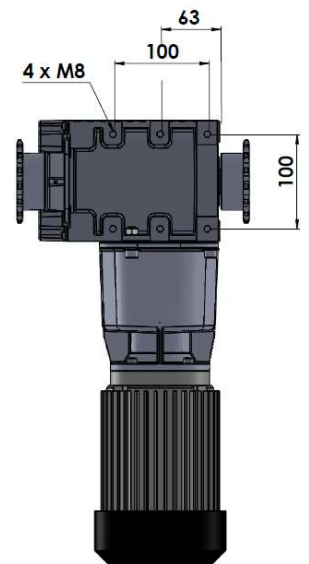
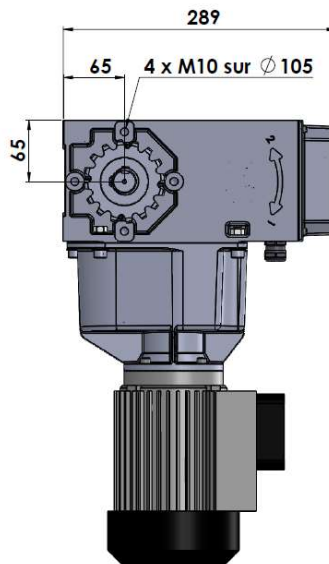
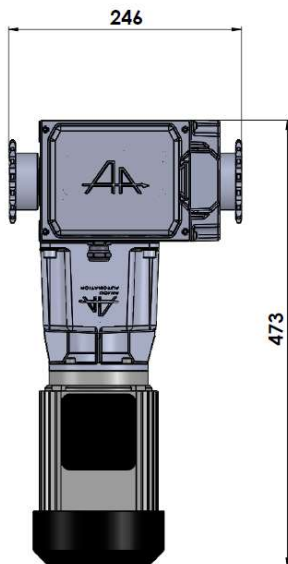

Description

Sealed construction in aluminium casing

Non reversible load

Manual operation on electric motor

Tool-free leak tight adjustable limit switch

Adjustable 33 rotation limit switch stroke

Location reserved for addition of the MISSI line

Two possible fixtures: side and back

Specifications

Torque	350Nm	
Coupling	Ø34 tubular chain	
Rotation speed	5.0rpm	
Motor power	0.55kW	
Three-phased	50Hz – 230/400V	2.6A
	60Hz – 280/460V	1.5A
Weight	26kg	